

User Manual

WA329/WR329/329P Series

Industrial 8 PoE+ with 1G WAN and Dual Radio LTE/Wi-Fi Routing Switch
for BUS/Vehicle

Oct.22.2018 V.1.0

WOM ASIA Co., Ltd

1F., No.185-3, Kewang Rd., Longtan Dist., Taoyuan 325, Taiwan

www.womaster.eu

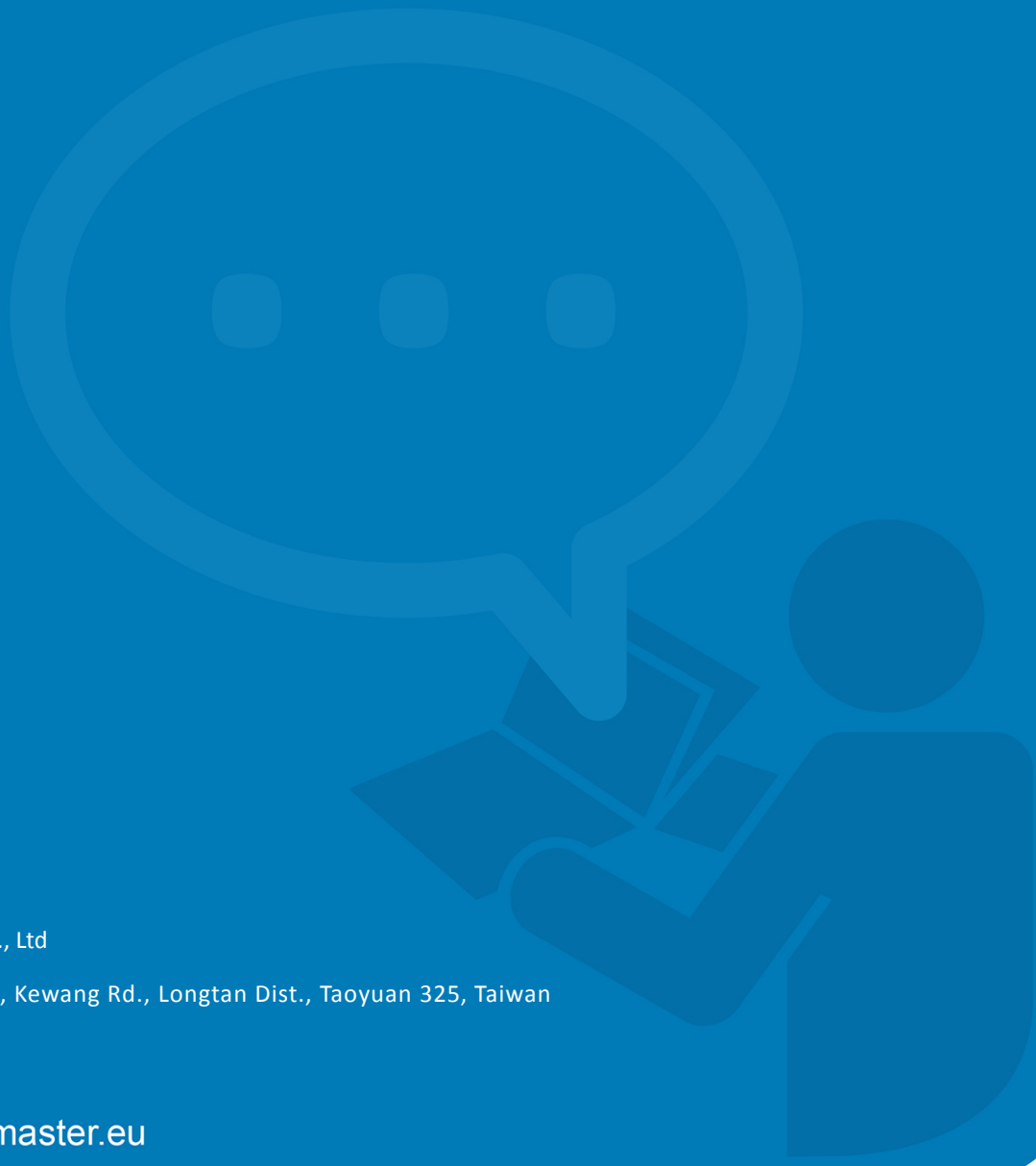

WoMaster

WA329/WR329/329P Series

Industrial 8 PoE+ with 1G WAN and Dual Radio LTE/WiFi Routing
Switch for BUS/Vehicle

User Manual

Copyright Notice

© WoMaster. All rights reserved.

About This Manual

This user manual is intended to guide a professional installer to install and to configure the WA329/329P Series. It includes procedures to assist you in avoiding unforeseen problems.



NOTE:

Only qualified and trained personnel should be involved with installation, inspection, and repairs of this router.

Disclaimer

WoMaster reserves the right to make changes to this Manual or to the product hardware at any time without notice. Information provided here is intended to be accurate and reliable. However, it might not cover all details and variations in the equipment and does not claim to provide for every possible contingency met in the process of installation, operation, or maintenance. Should further information be required or should particular problem arise which are not covered sufficiently for the user's purposes, the matter should be referred to WoMaster. Users must be aware that updates and amendments will be made from time to time to add new information and/or correct possible unintentional technical or typographical mistakes. It is the user's responsibility to determine whether there have been any such updates or amendments of the Manual. WoMaster assumes no responsibility for its use by the third parties.

WoMaster Online Technical Services

At WoMaster, you can use the online service forms to request the support. The submitted forms are stored in server for WoMaster team member to assign tasks and monitor the status of your service. Please feel free to write to help@womaster.eu if you encounter any problems.

TABLE OF CONTENTS

COVER.....	1
TABLE OF CONTENTS	3
1. INTRODUCTION	6
1.1 OVERVIEW	6
1.2 MAJOR FEATURES	8
2. HARDWARE INSTALLATION	9
2.1 HARDWARE DIMENSION	9
2.2 INSTALLATION.....	12
2.3 WIRING THE POWER INPUTS	12
2.4 WIRING THE ALARM RELAY OUTPUT (DO).....	13
2.5 CONNECTING THE GROUNDING SCREW	13
2.6 WALL MOUNTING.....	13
2.7 ANTENNA	14
2.8 SIM/SD CARD INSTALLATION	16
3. WEB MANAGEMENT CONFIGURATION	17
3.1 SYSTEM.....	19
3.1.1 INFORMATION	19
3.1.2 LOGIN SETTING	20
3.1.3 NETWORK SETTING	24
3.1.4 DATE AND TIME	26
3.1.5 DHCP SERVER.....	27
3.2 ETHERNET PORT	29
3.2.1 PORT STATUS	29
3.2.2 PORT SETTING.....	30
3.2.3 TRAFFIC CONTROL.....	31
3.3 POWER OVER ETHERNET	32
3.3.1 PoE STATUS.....	32
3.3.2 PoE CONTROL.....	33
3.3.3 PoE SCHEDULE.....	34
3.4 REDUNDANCY	35
3.4.1 VRRP	35
3.5 CELLULAR.....	38
3.5.1 CELLULAR STATUS	38
3.5.2 CELLULAR SETTING.....	40

3.5.3 SIM SETTING	42
3.5.4 DDNS	43
3.6 GPS.....	44
3.6.1 GPS STATUS	44
3.6.2 GPS SETTING	45
3.7 WIRELESS LAN	46
3.7.1 WLAN STATUS.....	46
3.7.2 WLAN SETTING.....	47
3.7.3 WLAN SECURITY.....	60
3.7.4 ADVANCED.....	63
3.7.5 ACCESS CONTROL (AP MODE)	65
3.7.6 RADIUS SERVER (AP MODE)	66
3.7.7 CERTIFICATE FILE (CLIENT MODE)	67
3.7.8 AUTO OFFLOAD (CLIENT MODE).....	67
3.8 SECURITY	69
3.8.1 ACCESS CONTROL.....	69
3.8.2 OUTBOUND FIREWALL	73
3.8.3 NAT SETTING.....	77
3.8.4 OPEN VPN	80
3.8.5 IPSEC SETTING.....	86
3.8.6 GRE SETTING	88
3.9 ROUTING	89
3.9.1 STATIC ROUTE	89
3.9.2 RIPv2.....	90
3.10 WARNING	90
3.10.1 EMAIL ALERT.....	90
3.10.2 PING WATCHDOG.....	91
3.10.3 SYSLOG SETTING	92
3.10.4 RELAY OUTPUT.....	93
3.10.5 EVENT TYPE.....	93
3.10.6 SNMP	94
3.11 DIAGNOSTICS	98
3.11.1 EVENT LOGS	98
3.11.2 ARP TABLE.....	99
3.11.3 PORT STATISTICS.....	100
3.11.4 PING.....	101
3.11.5 TRACEROUTE.....	101
3.11.6 ASSOCIATION LIST	102
3.12 IoT	103
3.12.1 AWS IoT	103

3.12.2 AZURE IoT	106
3.12.3 PRIVATE IoT	109
3.12.4 RMS	113
3.13 BACKUP AND RESTORE	119
3.14 FIRMWARE UPGRADE	120
3.15 RESET TO DEFAULTS	121
3.16 SAVE	121
3.17 LOGOUT	122
3.18 REBOOT	122
3.19 WOMASTER MIB.....	123
4. REVISION HISTORY	124

1. INTRODUCTION

1.1 OVERVIEW

WA329/WR329/329P Series is an Innovative and Intelligent LTE/Wi-Fi routing switch that is designed to combine functionalities of LTE/Wi-Fi router and 8-Port power boost PoE+ switch for Smart Bus applications where the WA329 offers dual radios Wi-Fi for local coverage, 1-port Gigabit WAN and optional SD, serial, DI/DO interfaces expansion. Besides, the P Series offers 8-port Fast Ethernet PoE/PoE+ functionality. The flexible modular design allows project customizations of enable/disable POE ports, LTE/Wi-Fi, or add serial /IO ports. Wide Temperature and Ruggedized design allows convenient deployment in existing infrastructure under the harsh conditions.

The WA329/WR329/329P Series provides 1-port Gigabit Ethernet WAN port for uplink connection or NVR. The USB design helps easy field installation. The SD card can store application programs or diagnostic log file. This industrial switch also can be smartly configured by WoMaster advanced management utility, Web Browser, SNMP, Telnet and Command Line Interface.

Excellent security features also provided, such as Firewall, Demilitarized Zone (DMZ), Port Forwarding, HTTPs, SSH for Telnet security, and many other security features. All of these features in order to ensure the secure data communication.

WoMaster' Industrial switch is designed to provide fast, secure, and more stable network. One advantage that makes it a powerful switch is that it equips with redundancy technologies such as cellular to WLAN auto offload and also WAN/LTE redundancy. Besides, IEC 61000-6-2 / 61000-6-4 Heavy Industrial and wayside EN50121-4 EMC certified design, rugged enclosure and -40~75°C wide operating temperature range, all of these features guarantee stable performance of WA329/WR329/329P Series for data transmission for Smart Bus or Vehicle Application. It can also be used in roadside cabinets or other industrial applications for ultra-resilient high-speed Wi-Fi & multi-port Ethernet ports to LTE routing.

Model Name	Description
WR309	Industrial 8+1G port Routing Switch
WR309P	Industrial 8+1G port PoE Routing Switch
WA329	Industrial 8+1G port Wireless AP/Client, Dual 802.11ac/n WLAN
WA329P	Industrial 8+1G port PoE Wireless AP/Client, Dual 802.11ac/n WLAN
WR329-WLAN+LTE-E	Industrial 8+1G port Cellular Ethernet Routing Switch, 802.11ac/n WLAN, LTE-E, FDD B1/3/5/7/8/20, TDD B38/40/41
WR329-WLAN+LTE-CN	Industrial 8+1G port Cellular Ethernet Routing Switch, 802.11ac/n WLAN, LTE-CN, FDD B1/B3/B5/B8, TDD B38/B39/B40/B41
WR329-WLAN+LTE-U	Industrial 8+1G port Cellular Ethernet Routing Switch, 802.11ac/n WLAN, LTE-U, FDD B2/4/12, B2/B4/B5@WCDMA

WR329P-WLAN+LTE-E	Industrial 8+1G port Cellular PoE Routing Switch, 802.11ac/n WLAN, LTE-E, FDD B1/3/5/7/8/20, TDD B38/40/41
WR329P-WLAN+LTE-CN	Industrial 8+1G port Cellular PoE Routing Switch, 802.11ac/n WLAN, LTE-CN, FDD B1/B3/B5/B8, TDD B38/B39/B40/B41
WR329P-WLAN+LTE-U	Industrial 8+1G port Cellular PoE Routing Switch, 802.11ac/n WLAN, LTE-U, FDD B2/4/12, B2/B4/B5@WCDMA

1.2 MAJOR FEATURES

Below are the major features of WR329P Series:

- Supports 8x Fast Ethernet ports, provides 100M wire-speed switching and supports 1x Gigabit Ethernet WAN port for uplink or NVR
- Provides 8-port IEEE 802.3af/at compliance PoE+, up to **30W** per port (PoE Series)
- LTE Cat.4, 2x2 MIMO, 150M downlink and 50M uplink.
- IEEE 802.11ac compliant & backward compatible with 802.11a/b/g/n with selectable 5G/2.4G Wi-Fi for local coverage, up to 866Mbps bandwidth per radio.
- Advanced management features: IPv4/IPv6, DDNS, SNMP v1/v2c/v3/Trap, MIBs, LLDP, DHCP server/client, TFTP, System Log.
- Cellular Configuration: Radio on/off, 4G LTE/3G HSPA Configuration, SIM Security, Connection Status, Cellular to Eth-WAN Redundancy, GPS positioning.
- WLAN Configuration: WLAN Basic Settings: Radio on/off, 2.4G 11n/5G 11ac Band and Frequency selection, SSID/Multi-SSID configuration, SSID broadcast, VLAN ID, WLAN to LAN Link fault pass-through, Cellular to WLAN Auto Offload and advanced WLAN settings, 802.1X.
- Wireless redundancy: Cellular to Eth-WAN Redundant, wireless auto offload
- Advanced Security system by OpenVPN, IPsec, Firewall, DMZ, Port Forwarding, HTTPs Login and SSH Telnet
- Event Notifications through E-mail, SNMP trap and SysLog
- Traffic Management features: NAT Routing and Traffic control.
- CLI interface, Web GUI, Telnet, and SNMP for network Management
- Multiple event relay output for enhanced alarm control
- EN50121-4 for Industrial IoT, ITS, Railway track side application.
- Effective heat dissipation design for operating in -40~75°C environments
- IP31 ingress protection

2. HARDWARE INSTALLATION

This chapter introduces hardware and contains information on installation and configuration procedures.

2.1 HARDWARE DIMENSION

Dimensions of WR309/309P: 200 x 55.5 x 126.5 (W x H x D) / without DIN Rail Clip

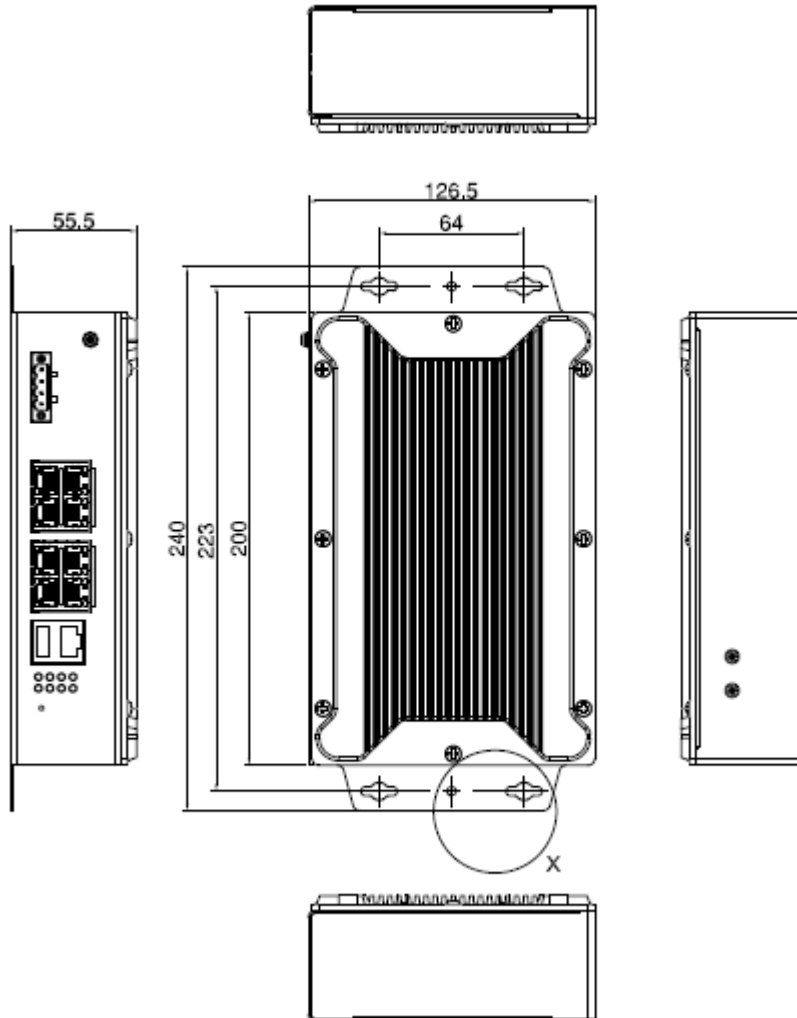

Dimensions of WA329/WR329/329P: 200 x 55.5 x 126.5 (W x H x D) / without DIN Rail Clip

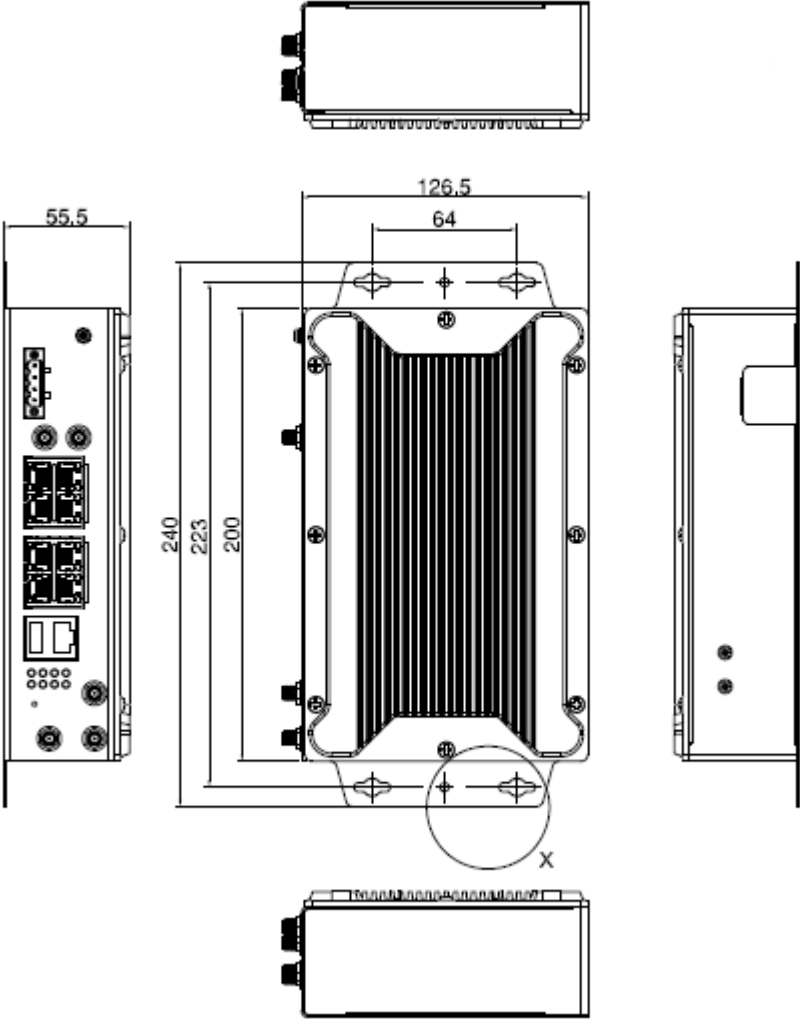

Front Panel Layout

The front panel from WR309/309P/WA329/WR329/329P includes 8 Fast Ethernet (10/100M ports, provides 100M wire-speed switching), supported with PoE for the PoE model, 1 Gigabit Ethernet WAN port (100/1000 Base-T, RJ45), System LED, USB for configuration/firmware management, 1 x 4-pin terminal block connector (2 pin for power inputs and 2 pin for DO alarm) and 1 chassis grounding screw. There is 2 wall mounting brackets are attached. For the SMA Antenna Socket, WA329/WR329/329P is supported up to 5 antennas socket and WR309 is not supported.

WR309/309P

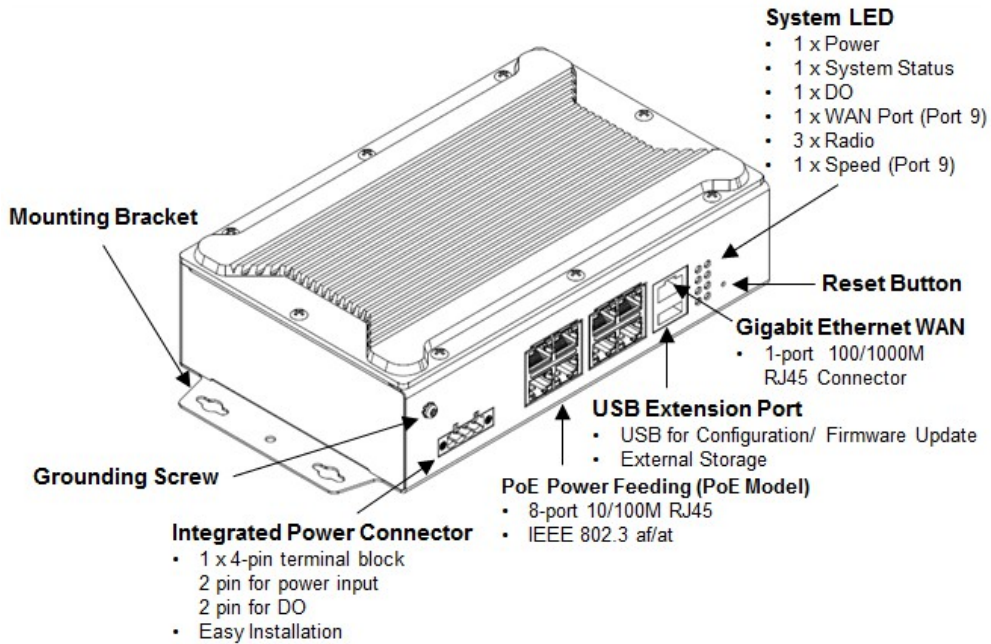

WA329/WR329/329P

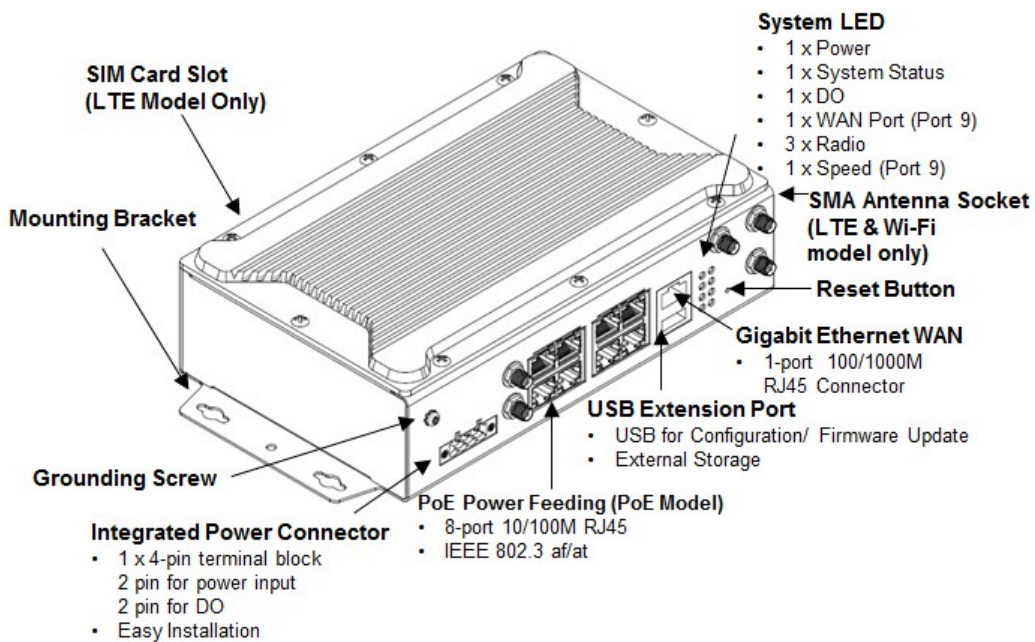

2.2 INSTALLATION

After unpack the box, follow the steps below in order to properly connect the device. For better LTE/Wi-Fi performance, put the device in a clearly visible spot, as obstacles such as walls and doors hinder the signal.

1. First, assemble router by attaching the necessary antennas and inserting the SIM card.
2. To power up router, please use the power adapter included in the box.

WARNING: Using a different power adapter can damage and void the warranty for this product

2.3 WIRING THE POWER INPUTS

Power Input port in the router provides 2 sets of power input connections (P1 and P2) on the terminal block. On the picture below is the power connector.

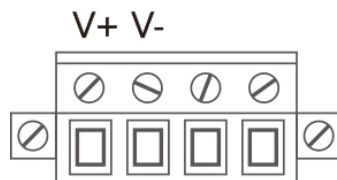

Wiring the Power Input

1. Insert the positive and negative wires into the V+ and V- contact on the terminal block connector.
2. Tighten the wire-clamp screws to prevent the power wires from being loosened.
3. Connect the power wires to suitable DC Switching type power supply. The input DC voltage should be in the range.

WA/WR329P: 12/24VDC (8~32VDC with booster to 54V) min. 8V low-peak auxiliary voltage

WA/WR329: 12/24VDC (8~32VDC)

WARNING: Turn off DC power input source before connecting the Power to the terminal block connectors, for safety purpose. Don not turn-on the source of DC power before all of the connections were well established.

2.4 WIRING THE ALARM RELAY OUTPUT (DO)

The relay output contacts are located on the front panel of the router. The relay output consists of the 2-pin terminal block connector that used to detect user-configured events. The two wires attached to the fault contacts form a close circuit when a user-configured event is triggered. If a user-configured event does not occur, the fault circuit remains open. The fault conditions such as power failure, Ethernet port link break or other pre-defined events which can be configured in the device. Screw the DO wire tightly after digital output wire is connected.

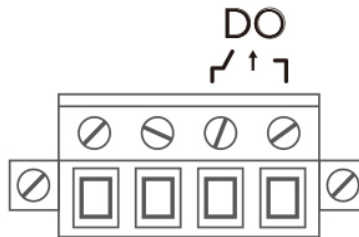

NOTE: The relay contact only supports 0.5 A current, DC 24V. Do not apply voltage and current higher than the specifications.

2.5 CONNECTING THE GROUNDING SCREW

For the grounding screw is located on the front side of the router. Grounding Screw helps limit the effects of noise due to electromagnetic interference (EMI) such as lightning or surge protection. Run the ground connection from the ground screw to the grounding surface prior to connecting devices. And tighten and wire to chassis grounding for better durability.

2.6 WALL MOUNTING

The wall mounting plate should already attached at the device as shown by the following figures.

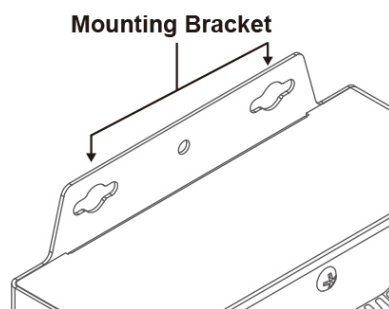

Follow the steps to install the device using wall-mounting plate:

1. The wall-mounting is installed on the device.
2. There are 4 hook holes, use the hook holes at the corners of the wall mounting plate to hang the switch on the wall.

2.7 ANTENNA

WR329P Series are supported with up to 5 antenna sockets, where 3G/LTE, GPS, and Wi-Fi antennas are supported.

All of the antennas are connected to the router by screwing all the antennas to the SMA connector on the front panel of the router.

WiFi Antenna

	Frequency	2400 ~ 2500 MHz 5150 ~ 5850 MHz
	S.W.R	<= 2.0 @ 2400 ~ 2500 MHz <= 2.0 @ 5150 ~ 5850 MHz The data is tested with 1M cable
	Peak Gain	2.5 ± 0.5 dBi @ 2400 ~ 2500 MHz 3.0 ± 0.5 dBi @ 5150 ~ 5850 MHz
	Efficiency	70 % @ 2400 ~ 2500 MHz 85 % @ 5150 ~ 5850 MHz
	Polarization	Linear
	Impedance	50 Ohm
	Connector Type	SMA Male Reverse
	Operational Temperature	- 40 °C ~ +65 °C

LTE Antenna

	Frequency	704 ~ 960 MHz 1710 ~ 2690 MHz
	V.S.W.R	<= 3.0
	Radiation	Omni
	Gain	2dBi
	Polarization	Vertical
	Impedance	50 Ohm
	Connector Type	Brass
	Operational Temperature	- 20 °C ~ +65 °C

NOTE: Please refer to device stick for antenna combination of different models

Antenna Placement

	WR309/309P	WA329 2xWLAN	WR329/329P-WLAN+LTE	WR329/329P-2xLTE
Ant 1	-	Wi-Fi 1	LTE-Main	LTE-Main
Ant 2	-	Wi-Fi 2	LTE-Aux	LTE-Aux
Ant 3	-	-	GPS	GPS
Ant 4	-	Wi-Fi 1	Wi-Fi 1	LTE-Main
Ant 5	-	Wi-Fi 2	Wi-Fi 2	LTE-Aux

Check the picture below for the antenna installation.

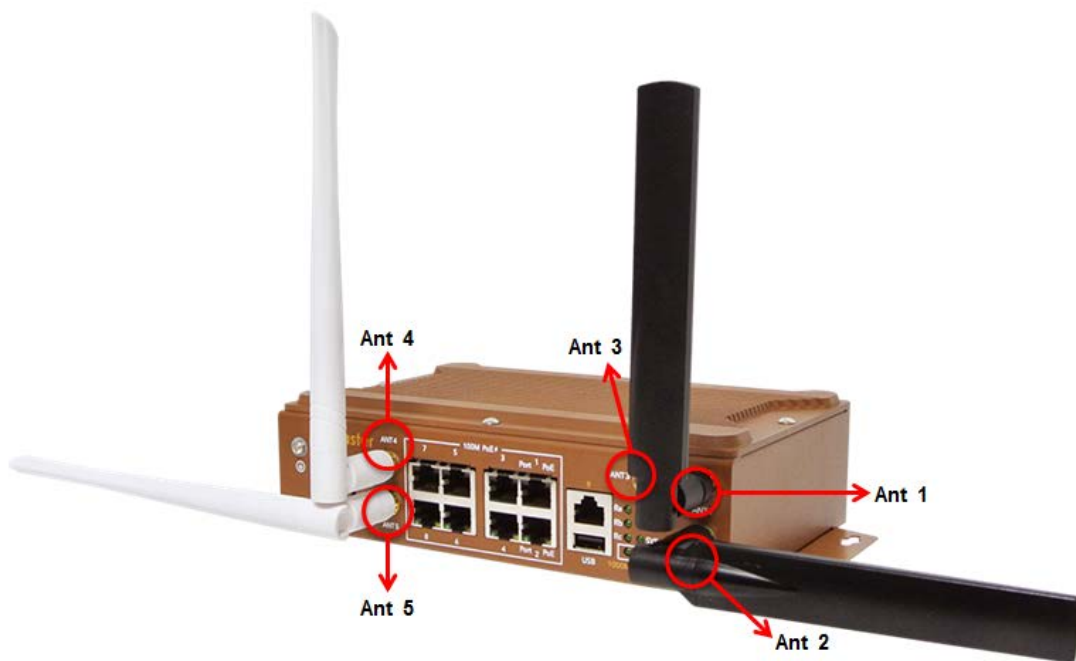

WA329/WA329P Radio LED

LED	Type	Description
Ra	Reserved	Reserved
Rb	Wi-Fi 1	AP mode: Green On Station mode connected: Green Blinking Station mode/radio disable: Off
Rc	Wi-Fi 2	AP mode: Green On Station mode connected: Green Blinking Station mode/radio disable: Off

WR329-WLAN+LTE/WR329P-WLAN+LTE Radio LED

LED	Type	Description
Ra	LTE	SIM detected: Green On SIM not detected: Off
Rb	LTE	4G connection: Green On

		2/3G connection: Green blinking Disconnected: Off
Rc	Wi-Fi	Station mode connected: Green Blinking Station mode/radio disable: Off AP mode: Green On

WR329-2xLTE/WR329P-2xLTE Radio LED

LED	Type	Description
Ra	LTE	SIM1 and 2 detected: Green On SIM1 or 2 detected: Green Blinking SIM 1 and 2 not inserted: Off
Rb	LTE	4G connection: Green On 2/3G connection: Green blinking Disconnected: Off
Rc	LTE	4G connection: Green On 2/3G connection: Green blinking Disconnected: Off

2.8 SIM/SD CARD INSTALLATION

SIM Card Slot

The SIM Card Slot is used to insert the cellular card. The SIM Card Slot position is at the back panel of the device.

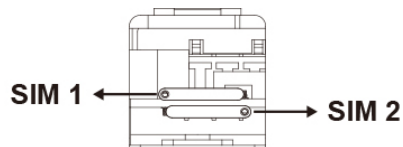

WARNING: Be careful when install the SIM Card, wrong installation procedure will cause damage.
Please follow the mechanical print out to install the SIM Card.

3. WEB MANAGEMENT CONFIGURATION

To access the management interface, WoMaster router has two ways access mode through a network; they are web management and telnet management. Web interface management is the most common way and the easiest way to manage a network, through web interface management, a router interface offering status information and a subset of device commands through a standard web browser. If the network is down, another alternative to access the management interface can be used. The alternative way is by using telnet management which is offer configuration way through CLI Interface. This manual describes the procedures for Web Interface and how to configure and monitor the managed router only.

PREPARATION FOR WEB INTERFACE MANAGEMENT

WoMaster provides Web interface management that allows user through standard web-browser such as Microsoft Internet Explorer, or Mozilla, or Google Chrome, to access and configure the router management on the network.

1. Plug the DC power to the router and connect router to computer.
2. Make sure that the router default IP address is **192.168.10.1**.
3. Check that PC has an IP address on the same subnet as the router. For example, the PC and the router are on the same subnet if they both have addresses that start 192.168.10.x (Ex: **192.168.10.2**). The subnet mask is 255.255.255.0.
4. Open command prompt and ping **192.168.10.1** to verify that the router is reachable.
5. Launch the web browser (Internet Explorer or Mozilla Firefox or Google Chrome) on the PC.
6. Type <http://192.168.10.1> (or the IP address of the router). And then press **Enter** and the login page will appear.
7. Type user name and the password. Default user name: **admin** and password: **admin**. Then click **Login**.

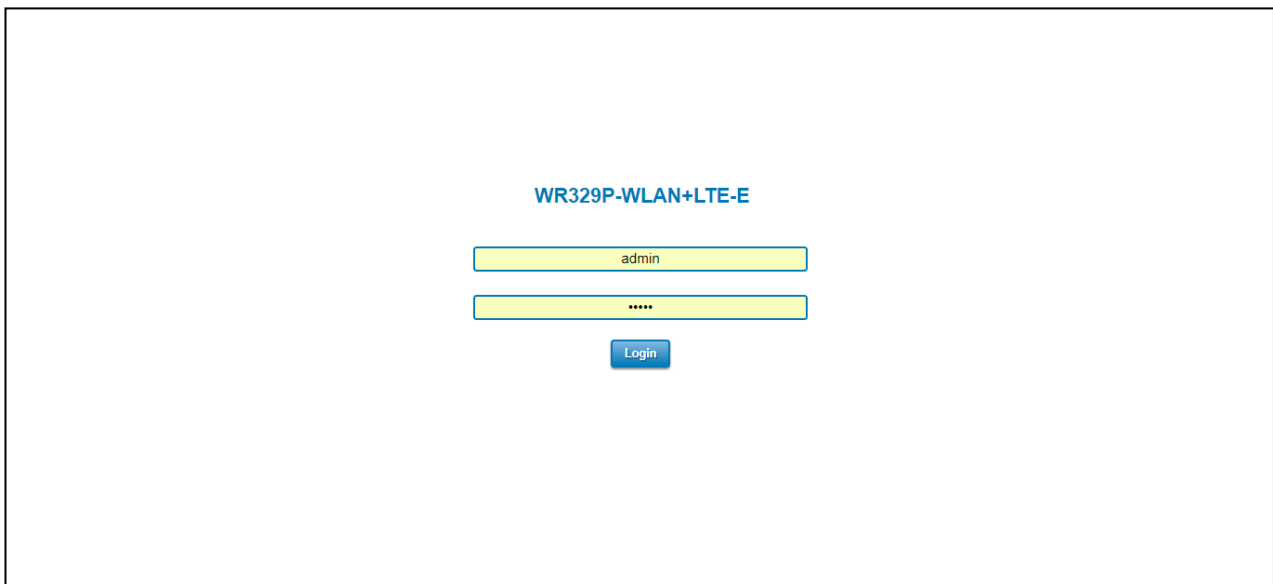

In this Web management for Featured Configuration, user will see all of WoMaster Cellular Router's various configuration menus at the left side from the interface. Through this web management interface, user can configure, monitoring, and set the administration functions. The whole information used web management interface to introduce the featured functions. User can use all of the standard web-browser to configure and access the router on the network.

Following topics are covered in this chapter:

- 3.1 System
- 3.2 Ethernet Port
- 3.3 Power over Ethernet
- 3.4 Redundancy
- 3.5 Cellular
- 3.6 GPS
- 3.7 Wireless LAN
- 3.8 Security
- 3.9 Routing
- 3.10 Warning
- 3.11 Diagnostics
- 3.12 IoT
- 3.13 Backup and Restore
- 3.14 Firmware Upgrade
- 3.15 Reset to Defaults
- 3.16 Save
- 3.17 Logout
- 3.18 Reboot
- 3.19 WoMaster MIB

3.1 SYSTEM

When the user login to the router, user will see the system section appear. This section provides all the basic setting and information or common setting from the router that can be configured by the administrator.

Following topics are included:

- 3.1.1 Information
- 3.1.2 Login Setting
- 3.1.3 Network Setting
- 3.1.4 Date and Time
- 3.1.5 DHCP Server

3.1.1 INFORMATION

Information section, this section shows the basic information from the router to make it easier to identify different router that is connected to User network and also it shows the Cellular Status and LAN Settings information. The figure below shows the interface of the Information section.

Home > System > Information

Information Login Setting Network Setting Date and Time DHCP Server ▾

WR329P-WLAN+LTE Industrial 8+1G port Cellular PoE Routing Switch, 802.11ac/n WLAN, LTE

System Name	<input type="text" value="router"/>
System Description	<input type="text" value="Industrial 8+1G port Cellular PoE Routing Switch, 802.11ac/n WLAN, LTE"/>
Software Version	<input type="text" value="1.0"/>
MAC Address	<input type="text" value="94:66:e7:82:31:24"/>
IP Address	<input type="text" value="192.168.10.60"/>
Subnet Mask	<input type="text" value="255.255.255.0"/>
Gateway IP Address	<input type="text" value="192.168.10.254"/>
USB Status	<input type="text" value="Not Insert"/>

The description of the Information's interface is as below:

TERMS	DESCRIPTION
System Name	Default: router Set up a name to the device.
System Description	Display the name of the product.
Software Version	Display the firmware latest version that installed in the device.
MAC Address	Display the hardware's MAC address that assigned by the manufacturer.
IP Address	Display the IP Address of the device
Subnet Mask	Display the subnet mask of the device

Gateway IP Address	Display the gateway IP Address of the device
USB Status	Display the USB port status when the USB is plugged or unplugged.

3.1.2 LOGIN SETTING

WoMaster' router supports Login Setting that has several authentication methods. It is supported with TACACS+, Radius, and Multi-User Authentication. This Login Setting consists of two level, admin and guest. Where the admin level, it has the privilege to read and write and for the guest level the privilege is read only. Below is the **Login Setting** section for **admin level**.

User Name:

New Password:

Confirm Password:

With the Name default setting is **admin** and the authority allow user to configure all of configuration parameters. The Login Setting interface describes how to configure the system username and password for the web management login. To change the Name and Password, user just needs to input a new Name and New Password then confirm the new password in this section. Try to re-login with the new User Name and Password.

Below is the interface for **guest level**.

Guest Name

New Password

Confirm Password:

With the Name default setting is **guest** and the authority allow user to read only all of configuration parameters.

NOTE: For security consideration, please change the password after first log in.

When user try to change the configuration, message will appear if user is not permitted to configure the configuration. Below is the interface.

Your permission is not enough to perform the action!

The description of the Login Setting interface is as below:

TERMS	DESCRIPTION
User Name/ Guest Name	Default: admin/guest Key in new username here.
New Password	Key in new password here.
Confirm Password	Re-type the new password again to confirm it.

After finishing configure the Username and Password, click on **Submit** to apply the configuration. Don't forget to **Save** the configuration.

Authentication Mode

The authentication can be performed locally and remotely using Radius or TACACS+ authentication server. It has 5 authentication modes which are Local, RADIUS, RADIUS->Local, TACPLUS, and TACPLUS->Local. The default authentication method is Local method, where it works for multi user authentication that has been explained above.

RADIUS

The Remote Authentication Dial-In User Service (RADIUS) protocol was developed by Livingston Enterprises as an access server authentication and accounting protocol. The RADIUS server can support a variety of methods to authenticate a user. When it is provided with the username and original password given by the user, it can support PPP, PAP or CHAP, UNIX login, and other authentication mechanisms. Below is the RADIUS and RADIUS to Local authentication mode interface. For the RADIUS to Local mode, the authentication will try remote authentication first, falling back to local authentication mode if remote mode fails.

Authentication Mode

Authentication Mode

RADIUS Server

RADIUS Server IP

Shared Key

Server Port

Secondary RADIUS Server

RADIUS Server IP

Shared Key

Server Port

How to set up a RADIUS server:

- a. Enter the IP address of the RADIUS server in **Server IP Address**
- b. Enter the **Shared Secret** of the RADIUS server
- c. Enter the **Server port** if necessary, by default RADIUS server listens to port 1812
- d. Click **Submit**

The description of the RADIUS Authentication interface is as below:

TERMS	DESCRIPTION
RADIUS Server IP	Radius Server IP Address
Shared Key	Shared key are used to verify that RADIUS messages, with the exception of the Access-Request message, are sent by a RADIUS-enabled device that is configured with the same shared key. Shared key also verify that the RADIUS message has not been modified in transit (message integrity).
Server Port	Set communication port of an external RADIUS server as the authentication database. The general value is 1812

TACACS+

The Terminal Access Controller Access Control System (TACACS+) security protocol is a recent protocol developed by Cisco. It provides detailed accounting information and flexible administrative control over the authentication and authorization processes. TACACS+ allows for a single access control server (the TACACS+ daemon) to provide authentication, authorization, and accounting services independently. Below is the interface for TACPLUS and TACPLUS to Local authentication mode. For the TACPLUS to Local mode, the authentication will try remote authentication first, falling back to local authentication mode if remote mode fails or cannot be reached.

Authentication Mode

Authentication Mode

TACPLUS Authentication Setting

Authentication Type

Authentication Timeout

TACPLUS Server

TACPLUS Server IP

Shared Key

Server Port

Secondary TACPLUS Server

TACPLUS Server IP

Shared Key

Server Port

How to set up a TACACS+ server:

- a. Select the **Authentication Type**.
- b. Enter the **Authentication Timeout** in seconds.
- c. Enter the IP address of the TACACS+ server in **Server IP Address**.
- d. Enter the **Shared Secret** of the TACACS+ server.
- e. Enter the **Server port** if necessary, by default TACACS+ server listens to port 49.

f. Click **Submit**

The description of the TACACS+ Authentication interface is as below:

TERMS	DESCRIPTION
Authentication Type	Default: ASCII Select the authentication type to authenticate to the server.
Authentication Timeout	Default: 5 The maximum number of seconds allowed establishing a TCP connection between the device and the TACACS+ server. If the server cannot be reached within the limit time, and it will directly change to Local. This configuration is applied to TACPLUS->Local mode only.
TACPLUS Server IP	TACACS+ Server IP Address
Shared Key	Specifies the shared key for TACACS+ communications between the device and the TACACS+ server. The shared key must match the encryption used on the TACACS+ server.
Server Port	Set communication port of an external TACACS+ server as the authentication database. The general value is 49

3.1.3 NETWORK SETTING

The Network Setting section allows users to configure both IPv4 values for management access over the network. WoMaster' router supports IPv4, and can be managed through either of these address types. In this page, user can change the network mode between Bridge mode or Router mode.

Below is the IP Setting interface for **Bridge Mode**.

The description of the columns is as below:

TERMS	DESCRIPTION
IP Assignment	User can select to DHCP or Static IP to activate the function. DHCP: Select DHCP to activate DHCP Client Function, no need to assign IP Address and received IP Address from DHCP Server. Static IP: Select Static IP to configure the IP configuration manually
IP Address	Default: 192.168.10.1 Set up the IP address reserved by User network for User device. If DHCP Client function is enabled, no need to assign an IP address to device as it will be overwritten by DHCP server and shown here.
Subnet Mask	Default: 255.255.255.0 Assign the subnet mask for the IP address here. If DHCP Client function is enabled, no needs to assign the subnet mask.
Gateway IP Address	Default: 0.0.0.0. Assign the gateway for the device here.
DNS 1	Specifies the IP address of the DNS server 1 that used in user network.
DNS 2	Specifies the IP address of the DNS server 2 that used in user network.

And below is the IP Setting interface for the **Router Mode** where it supports with the WAN port on port 1. User can configure the WAN Settings.

IP Setting

WAN Settings

WAN Access Type:

IP Address:

Subnet Mask:

Default Gateway:

DNS 1:

DNS 2:

LAN Settings

IP Address:

Subnet Mask:

The IPv4 Configuration includes the router’s IP address and subnet mask, as well as the IP address of the default gateway. In addition, input cells are provided for the IP addresses of a 1st and 2nd DNS server. Configure the managed router’s IP settings. The figure above shows the user interface of IPv4 Configuration.

The description of the columns is as below:

TERMS	DESCRIPTION
WAN Access Type	User can select to DHCP Client or Static IP to activate the function. DHCP Client: Select DCHP Client to activate DHCP Client Function, no need to assign IP Address and received IP Address from DHCP Server. Static IP: Select Static IP to configure the IP configuration manually
IP Address	Default: 192.168.1.1 Set up the IP address reserved by User network for User device. If DHCP Client function is enabled, no need to assign an IP address to device as it will be overwritten by DHCP server and shown here.
Subnet Mask	Default: 255.255.255.0 Assign the subnet mask for the IP address here. If DHCP Client function is enabled, no needs to assign the subnet mask.
Gateway IP Address	Default: 0.0.0.0. Assign the gateway for the device here.
DNS 1	Specifies the IP address of the DNS server 1 that used in user network.
DNS 2	Specifies the IP address of the DNS server 2 that used in user network.

Proxy ARP

Proxy ARP is a technique in which one host, usually a router answers ARP requests intended for another node located on another network. The router or "faking" its identity or pretends to be the target of the ARP requests by sending ARP responses that associate its own MAC address with the real (destination) node’s IP address. The router acts as a

proxy and takes responsibility for routing packets to the real destination. Proxy ARP can help machines on a subnet reach remote subnets without the need to configure routing or a default gateway.

When Proxy ARP is enabled, if the router receives an ARP request for which it has a route to the target (destination) IP address, the router responds by sending a Proxy ARP reply packet containing its own MAC address. The host that sent the ARP request then sends its packets to the router, which forwards them to the intended host.

Below is the interface.

Check the box to enable the function of Proxy ARP.

3.1.4 DATE AND TIME

The WoMaster router has a time calibration function based on information from an NTP server or user specified time and date, allowing functions such as automatic warning emails to include a time and date stamp.

The description of the columns is as below:

TERMS	DESCRIPTION
Current Time	User can configure time by input it manually. User also can click the Get PC Time to get the time setting. Get PC Time: get the time the PC
Time Zone	Choose the Time Zone section to adjust the time zone based on the user area.
NTP	Enable NTP Client update by checking this box. Select the time server from the NTP Server dropdown list or select Manual IP to manually input the IP address of available time server. *Make sure that the device also has the internet connection.

After finished configuring, click on **Submit** to activate the configuration.

3.1.5 DHCP SERVER

DHCP Server Setting

WoMaster router has DHCP Server Function that will provide a new IP address to DHCP Client. After enabling DHCP Server function, set up the Network IP address for the DHCP server IP address, Subnet Mask, Default Gateway address and Lease Time for client. Below is the DHCP Server Setting interface

DHCP Server

DHCP Settings:

IP Address Start :

IP Address End :

Subnet Mask:

Gateway:

WINS1 :

WINS2 :

Primary DNS Server :

Secondary DNS Server :

Lease Time : (15-44640 Minutes)

The description of the columns is as below:

TERMS	DESCRIPTION
DHCP Setting	Select to Enable or Disable to activate and deactivate DHCP Server function.
IP Address Start	Assign the IP Address Start range.
IP Address End	Assign the IP Address End range.
Subnet Mask	Default: 255.255.255.0 Assign the subnet mask for the IP address here for DHCP Server.
Gateway	Assign the gateway for the router here for DHCP Server.
WIN S1	Enter WINS Server 1 IP address
WIN S2	Enter WINS Server 2 IP address
Primary DNS Server	Enter Primary DNS Server that used in user network.
Secondary DNS Server	Enter Secondary DNS Server that used in user network.
Lease Time	Default: 1440 The maximum length of time for the IP address lease. Enter the Lease time in minutes. (Lease Time range: 15-44640 minutes)

The DHCP Server will automatically assign an IP address to the computers on the LAN/private network. Be sure to set user computers to be DHCP clients by setting their TCP/IP settings to "Obtain an IP Address Automatically." When user turns the computers on, they will automatically load the proper TCP/IP settings provided by the router. If User

manually assigns IP addresses to User computers or devices, make sure the IP addresses are outside of this range or User may have an IP conflict. After finished configuring, click on **Submit** to activate the configuration.

DHCP Leased Entries

The figure below shows the **DHCP Leased Entries**. It will show the MAC and IP address that was assigned by router. Click the **Reload** button to refresh the list.

DHCP Leased Entries		
IP Address	MAC Address	Time to expire(s)
192.168.10.101	94:66:e7:ff:11:92	86379

Reload

The description of the columns is as below:

TERMS	DESCRIPTION
IP Address	IP address that was assigned by router.
MAC Address	The MAC Address of the network interface that was used to acquire the lease.
Time to expire(s)	Remains time for the IP address from DHCP Server leased.

3.2 ETHERNET PORT

Ethernet Port section is used to access the port configuration and rate limit control. It also allows User to view port status and port trunk information.

Following items are included in this group:

3.2.1 Port Status

3.2.2 Port Setting

3.2.3 Traffic Control

3.2.1 PORT STATUS

Port Status page provides current port status.

Port Status			
Port	Link	Speed/Duplex	Flow Control
1	Down	100 Full	Disable
2	Down	100 Full	Disable
3	Down	100 Full	Disable
4	Down	100 Full	Disable
5	Down	100 Full	Disable
6	Down	100 Full	Disable
7	Up	100 Full	Disable
8	Down	100 Full	Disable
9	Down	1000 Full	---

Reload

The description of the columns is as below:

TERMS	DESCRIPTION
Port	Shows port number
Link	Shows the port link status which is Link Up or Link Down. Up means the connection is established and Down means there is no connection.
Speed/Duplex	Shows the Speed/Duplex status 100 full, 100 half, 10 full, 10 half mode for Fast Ethernet Port 1~8 (fe1~fe8) . For Gigabit Ethernet Port 9: (ge9) , it can be set up to 100 full and 100 half (Auto Negotiation – 1000)
Flow Control	Default: Disable Enable means that User need to activate the flow control function in order to let the flow control of that corresponding port on the switch to work. Disable means that User doesn't need to activate the flow control function, as the flow control of that corresponding port on the switch will work anyway. For Port 9, it is no supported.

Click on **Reload** to update the information.

3.2.2 PORT SETTING

Port Settings section allows users to enable or disable each port function; state the speed/duplex of each port; and enable or disable the flow control of the port.

Port Status
Port Setting
Traffic Control

Port	State	Speed/Duplex	Flow Control
1	Enable ▼	AutoNegotiation ▼	Disable ▼
2	Enable ▼	AutoNegotiation ▼	Disable ▼
3	Enable ▼	AutoNegotiation ▼	Disable ▼
4	Enable ▼	AutoNegotiation ▼	Disable ▼
5	Enable ▼	AutoNegotiation ▼	Disable ▼
6	Enable ▼	AutoNegotiation ▼	Disable ▼
7	Enable ▼	AutoNegotiation ▼	Disable ▼
8	Enable ▼	AutoNegotiation ▼	Disable ▼
9	Enable ▼	AutoNegotiation ▼	---

Submit
Cancel

The description of the Ethernet Setting page is as below:

TERMS	DESCRIPTION
Port	Shows port number
State	Default: Enable Enable or disable a port
Speed/Duplex	Default: AutoNegotiation Users can set the bandwidth of each port as Auto-negotiation, 100 full, 100 half, 10 full, 10 half mode for Fast Ethernet Port 1~8 (fe1~fe8) . For Gigabit Ethernet Port 9: (ge9) , it can be set up to 100 full and 100 half (Auto Negotiation – 1000).
Flow Control	Default: Disable Enable means that User need to activate the flow control function in order to let the flow control of that corresponding port on the switch to work. Disable means that User doesn't need to activate the flow control function, as the flow control of that corresponding port on the switch will work anyway. Port 9 is not supported.

Click **Submit** to apply the configuration that just made.

3.2.3 TRAFFIC CONTROL

Traffic control is a form of flow control used to enforce a strict bandwidth limit at a port. User can configure separate Incoming Outgoing rate limits and burst

Port Status | Port Setting | **Traffic Control**

(W)WAN Traffic Control

Enable Traffic Control

Incoming Rate Limit kbit/s

Incoming Burst kBytes

Outgoing Rate Limit kbit/s

Outgoing Burst kBytes

The description of the columns is as below:

TERMS	DESCRIPTION
Enable Traffic Control	Check the box to activate the function
Incoming Rate Limit	Default: 1024000 kbit/s Set the maximum incoming rate.
Incoming Burst	Default: 20 kBytes Set the maximum incoming burst.
Outgoing Rate Limit	Default: 1024000 kbit/s Set the maximum outgoing rate.
Outgoing Burst	Default: 20 kBytes Set the maximum outgoing burst.

Click on **Submit** to apply the configuration.

3.3 POWER OVER ETHERNET

Power over Ethernet has become increasingly popular due in large part to the reliability provided by PoE Ethernet switches that supply the necessary power to Powered Devices (PD) when AC power is not readily available or cost-prohibitive to provide locally. WoMaster router compliant with IEEE 802.3af and IEEE 802.3at features. All of WoMaster switches adapt 4-Port PoE injectors in port 1 to port 4, each port with the ability to deliver 30 - 60W to compatible IEEE 802.3at standard and provides 100W power budget for all systems.

Power over Ethernet can be used with:

- Surveillance cameras
- Security I/O sensors
- Industrial wireless access points
- Emergency IP phones

3.3.1 PoE STATUS

The PoE Status page shows the system PoE status and the operating status of each PoE Port. The information includes PoE mode, Operation status, and PD class, Power Consumption, Voltage, and Current. For example, in the figure below, Port 1 was enabled and is supplying power to a Class 3 Powered Device (PD) indicated under the Classification column. The PD device is rated at 53.3V and 0A. The total power consumption for this PD is 1.9 W with Budget 15W. To check the status of the PoE port, please click on the Reload button.

PoE Status							
Port	Mode	Status	Class	Budget(W)	Consumption(W)	Voltage(V)	Current(mA)
1	Disable	On	Class3	15	1.9	53.3	0.0
2	Disable	Off	---	---	0.0	0.0	0.0
3	Disable	Off	---	---	0.0	0.0	0.0
4	Disable	Off	---	---	0.0	0.0	0.0
5	Disable	Off	---	---	0.0	0.0	0.0
6	Disable	Off	---	---	0.0	0.0	0.0
7	Disable	Off	---	---	0.0	0.0	0.0
8	Disable	Off	---	---	0.0	0.0	0.0

[Reload](#)

The description of the columns is as below:

TERMS	DESCRIPTION
Mode	Enable/Disable/Schedule Indicates the PoE port status
Status	<p>Default: Off</p> <p>PoE status is included Off, Powering, and Searching.</p> <p>Off – PoE is inactive.</p> <p>Powering – PoE is enabled and powering the PD.</p> <p>Searching – Searching the PD which needs the power.</p>
Class	Indicates the PD included in which PoE class.

Budget(W)	Indicates the actual Budget value for PoE port
Consumption (W)	Indicates the actual Power consumed value for PoE port
Voltage (V)	Indicates the actual Voltage consumed value for PoE port
Current (A)	Indicates the actual Current consumed value for PoE port

3.3.2 PoE CONTROL

The figure below is **PoE Control** interface. In this section, user can enable or disable the PoE function, configure the Powering mode, the budget mode, and the set the budget. After finished configuring the settings, click on **Submit** to save the configuration.

PoE System Control

PoE System

Power Budget (W)

PoE Port Configuration

Port	Mode	Powering Mode	Budget Mode	Budget(W)	Priority
1	<input type="text" value="Enable"/>	<input type="text" value="802.3af"/>	<input type="text" value="Auto"/>	<input type="text" value="15.00"/>	<input type="text" value="Critical"/>
2	<input type="text" value="Disable"/>	<input type="text" value="802.3af"/>	<input type="text" value="Auto"/>	<input type="text" value="32.00"/>	<input type="text" value="Critical"/>
3	<input type="text" value="Disable"/>	<input type="text" value="802.3af"/>	<input type="text" value="Auto"/>	<input type="text" value="32.00"/>	<input type="text" value="Critical"/>
4	<input type="text" value="Disable"/>	<input type="text" value="802.3af"/>	<input type="text" value="Auto"/>	<input type="text" value="32.00"/>	<input type="text" value="Critical"/>
5	<input type="text" value="Disable"/>	<input type="text" value="802.3af"/>	<input type="text" value="Auto"/>	<input type="text" value="32.00"/>	<input type="text" value="Critical"/>
6	<input type="text" value="Disable"/>	<input type="text" value="802.3af"/>	<input type="text" value="Auto"/>	<input type="text" value="32.00"/>	<input type="text" value="Critical"/>

The description of the columns is as below:

TERMS	DESCRIPTION
Mode	Enable/Disable/Schedule port's PoE function.
Powering Mode	Port 1 – 8: 802.3af and 802.3at (2-event). *Forced mode will ignore the classification behaviors, uses the forced mode carefully.
Budget (W)	Allows user assign the budget control in this field.
Priority	Allows user to set the priority to deliver the PoE from Critical, High, and Low.

If the system PoE consumption is over the system budget control, the PoE system will turn off low priority port PoE function, until the consumption becomes smaller than the system budget. After finished configuring the settings, click on **Submit** to save the configuration.

3.3.3 PoE SCHEDULE

For energy saving or power recycle powered devices, the PoE managed switch's **PoE schedule** interface allows users to appoint any date and time to enable or disable PoE functions for each PoE port. User needs to configure **PoE Scheduling** and select a target port manually to enable this function. The figure below is PoE Schedule interface.

PoE Schedule

PoE Schedule on

Time	Sunday	Monday	Tuesday	Wednesday	Thursday	Friday	Saturday
00:00	<input type="checkbox"/>	<input type="checkbox"/>	<input type="checkbox"/>	<input type="checkbox"/>	<input type="checkbox"/>	<input type="checkbox"/>	<input type="checkbox"/>
01:00	<input type="checkbox"/>	<input type="checkbox"/>	<input type="checkbox"/>	<input type="checkbox"/>	<input type="checkbox"/>	<input type="checkbox"/>	<input type="checkbox"/>
02:00	<input type="checkbox"/>	<input type="checkbox"/>	<input type="checkbox"/>	<input type="checkbox"/>	<input type="checkbox"/>	<input type="checkbox"/>	<input type="checkbox"/>
03:00	<input type="checkbox"/>	<input type="checkbox"/>	<input type="checkbox"/>	<input type="checkbox"/>	<input type="checkbox"/>	<input type="checkbox"/>	<input type="checkbox"/>
04:00	<input type="checkbox"/>	<input type="checkbox"/>	<input type="checkbox"/>	<input type="checkbox"/>	<input type="checkbox"/>	<input type="checkbox"/>	<input type="checkbox"/>
05:00	<input type="checkbox"/>	<input type="checkbox"/>	<input type="checkbox"/>	<input type="checkbox"/>	<input type="checkbox"/>	<input type="checkbox"/>	<input type="checkbox"/>
06:00	<input type="checkbox"/>	<input type="checkbox"/>	<input type="checkbox"/>	<input type="checkbox"/>	<input type="checkbox"/>	<input type="checkbox"/>	<input type="checkbox"/>

The PoE schedule supports hourly and weekly base PoE schedule configuration. **Enable** and select the target port and marking the time frame, then click **Submit** to activate the PoE scheduling function on selected port.

3.4 REDUNDANCY

Redundancy role of the network is to help protect critical links against failure, protects against network loops, and keeps network downtime at a minimum. Sustainable, uninterrupted data communication network is critical for industrial applications. Network Redundancy allows user to set up redundant loops in the network to provide a backup data transmission route in the event that a connection is inadvertently disconnected or damaged. This switch is supported with VRRP (Virtual Routing Redundancy Protocol). A VRRP (Virtual Router Redundancy Protocol) is a computer networking protocol aimed to eliminate the single point of failure by automatically assigning available IP routers to participating hosts. Using a virtual router ID (VRID) address and virtual router IP (VRIP) address to represent itself, a virtual router consists of two or more physical routers, including one master router and one or more backup routers. All routers in the virtual router group share the same VRID and VRIP. The master router provides primary routing and the backup routers monitor the status of the master router and become active if the master router fails. This is a particularly important feature for industrial applications, since it could take several minutes to locate the disconnected or severed connection.

3.4.1 VRRP

VRRP Setting

The field allows user to create the Virtual Router Interface. All the layer 3 switches within the same VRRP domain should be located within the same IP network and equips with the same Virtual ID and Virtual IP address.

VRRP

Enable VRRP

Virtual Router ID

Virtual IP

Priority

Adv. Interval

Preempt Mode Enable Disable

Click **Submit** once finish the configuration. Then a new entry is created in the Virtual Router Interface Status section below. After the VRRP interface is created, user can see the new entry and adjust the settings to decide the policy of the VRRP domain.

TERMS	DESCRIPTION
Enable VRRP	Check the box to enable the function.
Virtual Router ID	This is a virtual ID range from 1~255. The switches within the same VRRP domain should have the same Virtual ID.
Virtual IP	This is the virtual IP of the VRRP domain. This is the Gateway IP of the clients.

Priority	The priority of the entry of this switch. In VRRP domain, the VRRP switches must have the same Virtual ID and Virtual IP settings and choose who should be the VRRP Master switch. The switch equips with the highest priority will be selected as the VRRP master. The priority setting field can be manually changed, the range is from 1~254, 255 for virtual IP owner and 100 for backup by default.
Adv. Interval	This field indicates how often the VRRP switches exchange the VRRP settings.
Preempt	While the VRRP Master link is failure, the VRRP Backup will take over its job immediately. However, while the VRRP master link is recovered, who should be the Master? The Preempt decide whether the VRRP master should be recovered or not. While the Preempt is Enable and the interface is VRRP Master, the interface will be recovered. While the Preempt is Disable and the interface is VRRP Master, there is no change while the link is recovered. The VRRP backup acts as the Master before restarting the switches.

Click the **Submit Selected** button to apply the configuration. Click the **Remove Selected** button to remove selected setting. Click the **Reload** button to reload table.

VRRP Status

The VRRP represent the Virtual Router Redundancy Protocol. To further ensure the high reliability of an environment, the Layer 3 switch supports the VRRP protocol allowing the hosts to continuously direct traffic to the default gateway without the default gateway configuration change.

Virtual Router Interface Status

Select	Virtual ID	Virtual IP	Priority	Adv. Interval	Preempt	VRRP Status	VRRP Mac	Edit
<input type="checkbox"/>	1	192.168.10.6	100	1	1	Disable	00:00:5E:00:01:01	Edit

[Delete Selected](#) [Delete All](#) [Refresh](#)

TERMS	DESCRIPTION
Interface	Show the interface for the VRRP domain.
VirtualID	This is a virtual ID range from 1~255. The switches within the same VRRP domain should have the same Virtual ID.
Virtual IP	This is the virtual IP of the VRRP domain. This is the Gateway IP of the clients.
Priority	The priority of the entry of this switch. In VRRP domain, the VRRP switches must have the same Virtual ID and Virtual IP settings and choose who

	should be the VRRP Master switch. The switch equips with the highest priority will be selected as the VRRP master. The priority setting field can be manually changed, the range is from 1~254, 255 for virtual IP owner and 100 for backup by default.
Adv. Interval	This field indicates how often the VRRP switches exchange the VRRP settings.
VRRP Status	While the VRRP Master link is failure, the VRRP Backup will take over its job immediately
VRRP MAC	This field indicates the VRRP MAC in this configuration entry.

Click **Refresh** to refresh the list. Click **Select** to the specific list then user can do several actions such as **Edit** and **Delete Selected**. Click **Delete All** to delete all of the list.

3.5 CELLULAR

This Cellular page provides the Cellular Status; configure Cellular Setting, and configure SIM Setting. This device is supported with redundant SIM and Dual SIM Card; user can choose SIM1 or SIM2 for the main SIM Card.

3.5.1 CELLULAR STATUS

The figure below shows Cellular Status.

The description of the columns is as below:

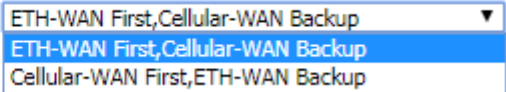
TERMS	DESCRIPTION
Cellular/ETH.WAN Redundancy	<p>Default: Disabled</p> <p>User can choose the redundancy mode:</p> <p>Cellular/ETH-WAN Redundancy </p> <p>ETH-WAN First, Cellular-WAN Backup: by choosing this mode, the redundancy mode would be like prioritize the ETH-WAN connection; if the ETH-WAN connection has a problem then the Cellular-WAN would be the backup connection.</p> <p>Cellular-WAN First, ETH-WAN Backup: by choosing this mode, the redundancy mode would be like prioritize the Cellular-WAN connection; if the Cellular-WAN connection has a problem then the ETH-WAN would be the backup connection.</p>
Modem Status	Display the modem status
Interface Status	Display the Cellular interface status Enabled or Disabled
Network Search Mode	Display the network search mode (Auto, 2G Only, 3G Only and LTE Only)

Current SIM Index	Display the current in used SIM card (1 or 2)
Provider	Display the ISP that user used.
APN	Every ISP has a specific APN (Access Point Name) assigned to its cellular network. The system can read this name from the SIM card.
Service Type	The connected ISP will update the service type here. The possible types are GSM – 2G, UMTS – 3G, GSM W/EGPRS, UTRAN W/HSDPA (download), UTRAN W/HSUPA(upload), UTRAN W/HSDPA and HSUPA(download & upload), E-UTRAN - LTE , No Service(default value)
IMEI	Display the International Mobile Equipment Identity (IMEI)
Signal Strength	<p>The signal strength to the remote connected base station. If the signal strength shows low, please change the device location or mounting the antenna in better location.</p> <p>Below are the signal strength definitions in our system:</p> <p>0 dBm (Default value while no connection)</p> <p>-113 dBm or less (Low)</p> <p>-111 dBm (Medium)</p> <p>-109...-53 dBm (Good)</p> <p>-51 dBm or greater (Excellent)</p> <p>-Not known or not detectable</p>
SIM Status	<p>Show the installed SIM Status.</p> <p>SIM OK: The SIM card is okay to use.</p> <p>SIM not inserted: The SIM card is not inserted.</p> <p>SIM PIN Locked: The SIM card is locked due to PIN error. It may be caused by error typing PIN password many times.</p> <p>SIM PUK Locked: The SIM Card PUK is locked due to PIN error after user three times input the wrong password. Contact the ISP to resolve the issue.</p>
Connection Status	<p>Connection Status:</p> <p>Connected: The cellular interface is connected.</p> <p>Not Connected: The cellular interface is not connected.</p>

3.5.2 CELLULAR SETTING

This section displays the Cellular Setting configuration page and also in this configuration page user may activate the redundant SIM function. In this section, user may configure the Cellular Interface, SIM Selection, Cellular Redundant, Network Type, SIM1/2 APN, User Name, Password and the Authentication mode.

The description of the columns is as below:

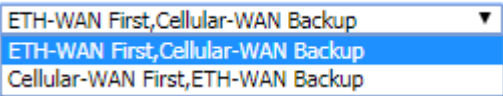
TERMS	DESCRIPTION
Cellular/ETH.WAN Redundancy	<p>Default: Disabled</p> <p>User can choose the redundancy mode:</p> <p>Cellular/ETH-WAN Redundancy </p> <p>ETH-WAN First, Cellular-WAN Backup: by choosing this mode, the redundancy mode would be like prioritize the ETH-WAN connection; if the ETH-WAN connection has a problem then the Cellular-WAN would be the backup connection.</p> <p>Cellular-WAN First, ETH-WAN Backup: by choosing this mode, the redundancy mode would be like prioritize the Cellular-WAN connection; if the Cellular-WAN connection has a problem then the ETH-WAN would be the backup connection.</p>
Cellular Interface	To enable or disable the cellular interface. Click check to disable the function.

SIM Selection	<p>Default: SIM1</p> <p>User can select the SIM card 1 or 2 that want to be activated or used.</p>
Cellular Redundant	<p>Default: Disable</p> <p>By enable this function, the SIM redundant function will be activated. The main function of this feature is to have the backup SIM if the main SIM card is unable to use or have a problem connection.</p> <p>Redundant Parameters configuration appears after the user enables the function. If the SIM card cannot be read after the redundant parameters are expired then it will directly change to read the other SIM card.</p> <p>Period: Set the period time to read the SIM card. The default value is 30 Seconds.</p> <p>Number of Entries: Set the number of entries to give the remaining trial to read the SIM card. The default value is 3.</p>
Network Type	<p>Set the Network Type, the option would be:</p> <p>Auto: Search the network automatically</p> <p>2G Only: only receive the 2G signal.</p> <p>3G Only: only receive the 3G signal.</p> <p>LTE Only: only receive LTE/4G signal.</p>
SIM1/2 APN	Set the APN of the ISP.
SIM1/2 User Name	Set the User Name
SIM1/2 Password	Set the password.
SIM1/2 Authentication	<p>Choose CHAP or PAP mode for the authentication mode.</p> <p>CHAP: Challenge Handshake Authentication Protocol, With CHAP, the authenticator (i.e. the server) sends a randomly generated "challenge" string to the client, along with its hostname.</p> <p>PAP: Password Authentication Protocol, PAP works basically the same way as the normal login procedure. The authenticates itself by sending a user name and a password to the server</p>

Click **Submit** to apply the configuration.

3.5.3 SIM SETTING

This section displays the SIM configuration such as SIM Status and SIM pin configuration. And in this section, user can enable or disable the SIM protection function. Apply the PIN number to the SIM cards; and make sure user enters the correct PIN number when activating the connection, after that the connection will start working. And also user can change the new PIN settings.

SIM Setting

Current SIM Index 1

SIM Status SIM OK

Number of Retries Remain: 2

SIM1 PIN:

Confirm SIM1 PIN:

Remember PIN: Enable Disable

PIN Protection: Disable

TERMS	DESCRIPTION
Current SIM Index	Display the current in used SIM Card slot (1 / 2)
SIM Status	<p>Show the installed SIM Status.</p> <p>SIM OK: The SIM card is okay to use.</p> <p>SIM not inserted: The SIM card is not inserted.</p> <p>SIM PIN Locked: The SIM card is locked due to PIN error. It may be caused by error typing PIN password many times.</p> <div style="border: 2px solid red; padding: 5px; margin-top: 10px;"> <p>WARNING: SIM PUK Locked status will appear when the SIM Card PUK is locked due to PIN error after user three times input the wrong password. Contact the ISP to resolve the issue.</p> </div>
Number of Retries Remain	Display the remaining chance to enter the PIN numbers.
SIM1/2 PIN	Enter new SIM1/2 PIN numbers
Confirm SIM1/2 PIN	Confirm the new SIM1/2 PIN numbers
Remember PIN	Click enable to save the PIN numbers
PIN Protection	<p>Activate the PIN protection feature. Choose the mode from the drop list.</p> <p>Disable PIN: Disable the PIN Protection feature</p> <p>Enable PIN: Activate the PIN Protection feature</p> <p>Change PIN: Change the PIN number, make sure user type the new PIN Number first at the SIM1 PIN textbox.</p>

Click **Submit** to apply the configuration.

3.5.4 DDNS

The DDNS (Dynamic Domain Name Service) is a method of keeping a domain name mapping to a dynamic public IP address. A dynamic public IP address is assigned for every connection request. After the user sets up the DDNS service, the DDNS service provider will automatically update the connection information if the public IP address has been changed. In this section, the user may configure the DDNS Setting.

DDNS Settings

Enable Dynamic DNS

Service Provider

Domain Name

Login Name

Password

Confirm Password

TERMS	DESCRIPTION
Enable Dynamic DNS	Check the box to enable the function
Service Provider	Select the Domain service provider from the list. <div style="border: 1px solid black; padding: 5px; margin-top: 10px;"> <p>Service Provider</p> <div style="border: 1px solid black; padding: 2px;"> <p>www.dyn.com(dynamic) ▼</p> <p>www.dyn.com(dynamic)</p> <p>www.dyn.com(custom)</p> <p>www.dyn.com(static)</p> <p>www.no-ip.com</p> <p>dynamic.zoneedit.com</p> </div> </div>
Domain Name	Enter the domain name
Login Name	Enter Login Name that used when applying the domain name
Password	Enter Password that used when applying the domain name
Confirm Password	Enter the Password once again to confirm.

Click **Submit** to apply the configuration.

3.6 GPS

This GPS section has the function to show the current position of the device. The purpose of this feature is to display the location of each device if there is device installation in large number. It could help the technician to track the device location. WoMaster GPS feature is supported with the Global Navigation Satellite Systems use satellite technology to provide insight on the geographic location of connected devices. GNSS is an inclusive term for the category of global systems including GPS, GLONASS, BeiDou, and Galileo. Modern positioning and timing modules have evolved to take advantage of multiple GNSS constellations at once. Combining multiple satellite systems improves availability of signals, gives operators more access, and increases accuracy. Recent driving tests combining GPS and GLONASS showed a noticeable improvement in both precision and performance when compared with single system results. Whether user is navigating a position in a crowded city, a vast desert, or a dense forest, utilizing multiple GNSS systems can help the device stays connected and centered.

3.6.1 GPS STATUS

The first configuration page is GPS Status, where user can see all of the GPS information such as the GPS Status, Date, UTC, Latitude, Longitude, Altitude (m), Speed over ground(Km/h) and the Number of satellites.

GPS Status	GPS Setting
GPS Status	
GPS	
Status	OK <input type="button" value="MAP"/>
Date	180418
UTC	052254.0
Latitude	24 58.4195N
Longitude	121 32.9160E
Altitude(m)	65.0
Speed over ground(Km/h)	0.0
Number of satellites	8
<input type="button" value="Reload"/>	

The description of the columns is as below:

TERMS	DESCRIPTION
Status	Display the GPS interface status OK or Disabled
Date	Display the current date.
UTC	Display the Coordinated Universal Time (UTC)
Latitude	Display the latitude of the coordinate

Longitude	Display the longitude of the coordinate
Altitude(m)	Display the altitude of the coordinate show the height or distance of an object from sea level.
Speed over ground(Km/h)	Display the speed over ground.
Number of satellites	Display the number of satellites that help to fix the position (Minimum 4 satellites).

At the status section, a MAP button appears. Click this button to show the specific location of your device through the Google Maps. After user clicks the button, the figure below will be appeared.

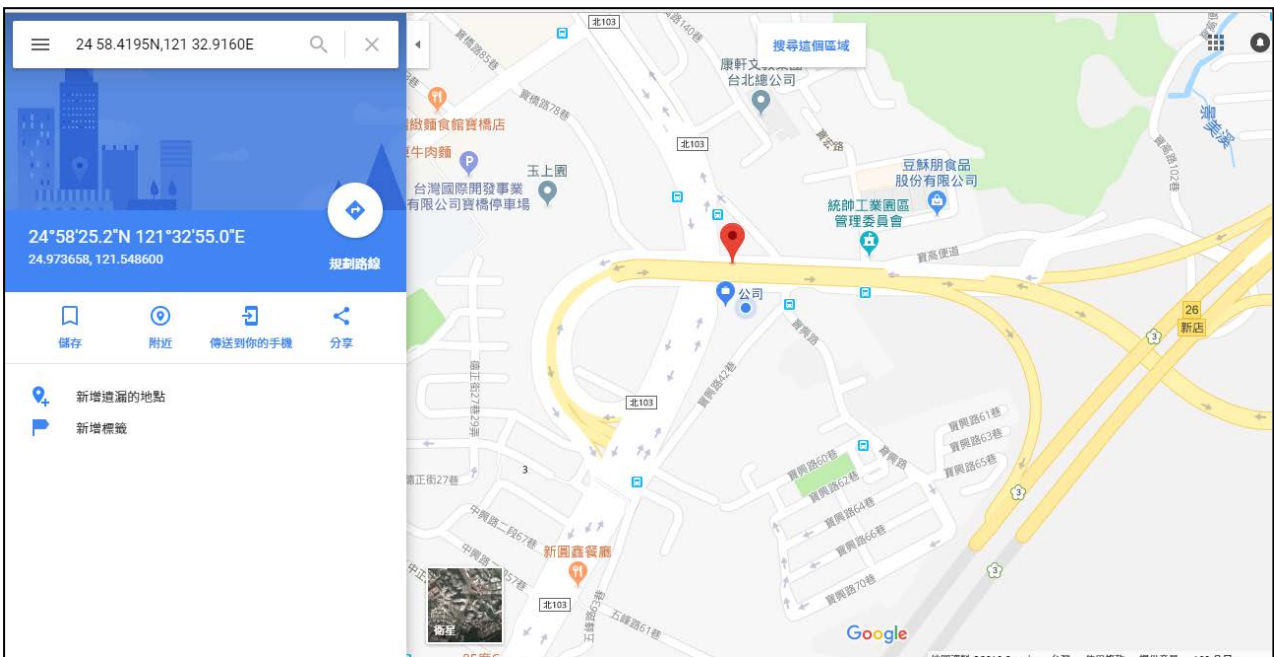

3.6.2 GPS SETTING

In this GPS Setting section, user can disable the GPS Interface by check the Disable. After user disables the function the GPS Status will show disabled status for the GPS function.

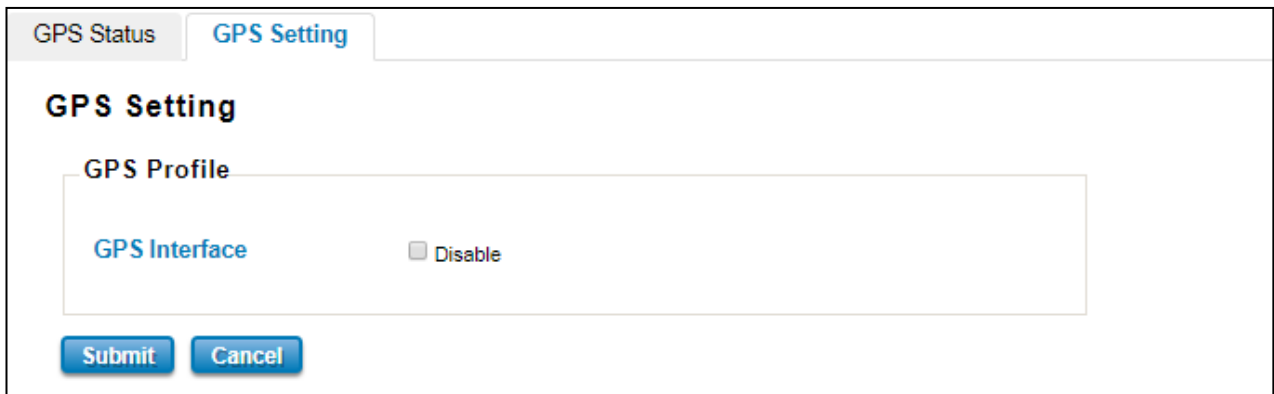

3.7 WIRELESS LAN

This Wireless LAN configuration pages only support the device that supported with Wi-Fi feature. This configuration page allows users to configure the Wireless LAN configuration. Several settings are provided here such as the WLAN Status, WLAN Setting, WLAN Security, Advanced and the Auto Offload.

3.7.1 WLAN STATUS

The figure below shows the WLAN status.

WLAN Status

Interface Status

Interface	Status	MAC Address	Frequency	Rate
WLAN 1	Up	04:f0:21:3b:8a:02	2437MHz (6)	Auto

WLAN 1

Operation Mode: AP

Wireless Mode: 802.11G/N

SSID: WR322_1

Encryption: Open System

WMM Enable: On

Noise Floor: -98 dBm

Reload

The description of the columns is as below:

TERMS	DESCRIPTION
Operation Mode	Display the current operating modes on the device
Wireless Mode	Display the current wireless mode
SSID	Display the primary name of the SSID
Encryption	Display the encryption mode.
WMM Enable	Display the status of the WMM support.
Noise Floor	Display the background noise level.

3.7.2 WLAN SETTING

WLAN Setting page, on this page user may configure the parameters for Wireless LAN Interface includes change wireless interface modes and all of the related parameters for each operation mode. And user can enable or disable the WLAN interface. For WA329/329P, it is supported with dual radio for Wi-Fi then in this WLAN Setting page, user can set the configure the Operation mode with one AP or one Wireless Client, both AP and both Wireless Client mode.

AP

The Access Point mode, it establishes a wireless connection, receive from wireless clients and provide connection for wireless client devices, the client can search and connect to several the access points. In AP mode interface, user can configure the SSID name, Enable or Disable Broadcast SSID, select the Wireless mode, set the HT Protect to Enabled or Disabled, set the Channel, Extension Channel, configures the Channel Mode, Maximum Output Power, Data Rate and Extension Channel Protection.

WLAN Setting

WLAN 1

WLAN Interface Disable

Operation Mode AP

SSID WR322_1 Multi SSID

Broadcast SSID Enabled Disabled

Wireless Mode 802.11G/N

HT protect Enabled Disabled

Channel 2437MHz (6)

Extension Channel None

Channel Mode 20 MHz

Maximum Output Power Half

Data Rate Auto

Extension Channel Protection None

Submit Cancel

The description of the columns is as below:

TERMS	DESCRIPTION
WLAN Interface	Check the box to disable the WLAN interface and stop all of the wireless functions.
Operation Mode	Default: AP Select the Operation Mode for the router. (AP, Wireless Client, WDS-AP and WDS-Client)

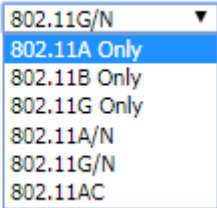
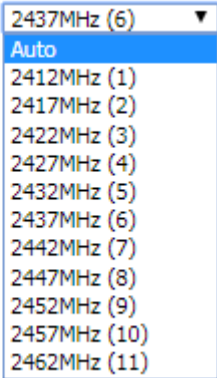
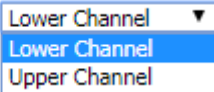
SSID	Default: WR322_1 Input the primary name of the access point.
Broadcast SSID	Default: Enabled. By enabling the broadcast SSID, it makes the AP can be accessed and searched by the clients, and for the security concern by disabling this broadcast SSID, the network will be hidden in order to prevent any malicious attack.
Wireless Mode	Default: 802.11G/N Select the specific wireless mode, different wireless mode has a different configuration. For each wireless mode, it has the specific frequency and it has different basic setting.. 
HT Protect	Default: Disabled Select Enabled to activate the High Throughput protect to ensure HT transmission with MAC mechanism.
Channel	Default: 2437MHz (6) Select the proper channel, each country has different band user may select the channel based on the situation. Or select auto to automatically set the channel. 
Extension Channel	Default: Lower Channel 2417MHz (2)  2417MHz (2) 40MHz Center Frequency This option would be appeared when user select the Channel Mode to 20/40MHz or 40MHz. To put range for the frequency, it provides the Lower Channel (2417MHz (2)) with the 40MHz center frequency is

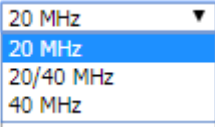
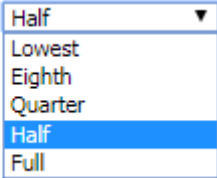
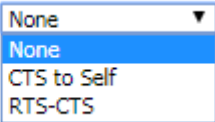
	2427MHz (4) and Upper Channel (2457MHz (10)) with the 40MHz center frequency is 2447MHz (8).
Channel Mode	<p>Default: 20MHz</p> <p>Channel Mode</p>  <p>There are three channel modes, 20MHz, 20/40MHz and 40MHz. If user select 20MHz, the frequency that can be received maximum is 20MHz. For 20/40MHz it can receive both frequency, and for the 40MHz, it provides bigger data rate and received the 40MHz frequency. But basically, if the transmission happened between the AP and the client, both AP and client can have the negotiation phase about the frequency.</p>
Maximum Output Power	<p>Default: Half</p> <p>Specify the transmission power. For the higher output power, it can cover the signal widely and of course may need big power consumption. The Full output power may need the antenna.</p> <p>Maximum Output Power</p> 
Data Rate	<p>Default: Auto</p> <p>Select the specific data rate in order to control the transmission rate. Auto is preferred rate, the access point will automatically select the highest available rate to transmit. User may select the low rate when there is no great demand for transmission speed, for long distance transmission.</p>
Extension Channel Protection	<p>Extension Channel Protection</p>  <p>Select from the dropdown list option between CTS-Self or RTS-CTS to avoid conflict with other wireless network and to improve the ability of the device to catch all the wireless transmissions. By activating this function it may decrease wireless network performance.</p>

Click **Submit** to apply the configuration

At the SSID section, there is a **Multi SSID** button appeared. This AP mode supports the multiple SSID or multiple access point connections. So user may separate the connection into several access points and it is supported with 8 profiles for multiple SSID. Click the button then another form will appear, see the figure below.

#	Profile Name	SSID	Security	Vlan ID	Enable
1	Profile1	WR322_1	Open System	1	Always Enabled
2	Profile2	WR322_1	Open System	1	<input type="checkbox"/>
3	Profile3	WR322_1	Open System	1	<input type="checkbox"/>
4	Profile4	WR322_1	Open System	1	<input type="checkbox"/>
5	Profile5	WR322_1	Open System	1	<input type="checkbox"/>
6	Profile6	WR322_1	Open System	1	<input type="checkbox"/>
7	Profile7	WR322_1	Open System	1	<input type="checkbox"/>
8	Profile8	WR322_1	Open System	1	<input type="checkbox"/>

Buttons: Back, Submit, Cancel

The description of the column is as below:

TERMS	DESCRIPTION
Profile Name	Display the available WLAN Profile name
SSID	Display the SSID Name.
Security	Display the current security mode for the Wireless network
VLAN ID	Display the VLAN ID
Enable	Check the box to enable the WLAN Profile. When user enabled the Profile, user may configure the WLAN Setting by click the Profile name.

Click **Submit** to apply the configuration

The Multi SSID section shows the configuration page where the Profile1 always enabled. In this section, user may configure each Profile by check the box to enable the Profile and then click the profile name to open the configuration page for specific Profile. The figure below is the pop-up WLAN Security configuration page for each Profile. In this configuration page, user can configure the AP profile, divide the AP connection and set the security setting by put the encryption mode and set the key or password to access the AP. Refers to the WLAN Security Section for more description (3.6.3).

WLAN Security Setting

General Setting

Profile Name: Profile2

SSID: WR322_1

Broadcast SSID: Enable Disable

Wireless Separation: Enable Disable

WMM Support: Enable Disable

Max. Station Num: 64 (0-64)

Security Setting (Setup Radius Server if Radius is enabled!)

Mode: Open System

Encryption: None

Key Type: Hex

Default Key: Key 1

Key 1: [Text Input]

Key 2: [Text Input]

Key 3: [Text Input]

Key 4: [Text Input]

Back Submit Cancel

Click **Submit** to apply the configuration

Wireless Client

Wireless Client mode, in this mode the device is able to connect to the Access Point and join the wireless network around the device that opens the connection. User can find the best connection for the AP by click the **Site Survey** and the AP list will appear.

The description of the columns is as below:

TERMS	DESCRIPTION
WLAN Interface	Check the box to disable the WLAN interface and stop all of the wireless functions.
Operation Mode	Select the Operation Mode for the router. (AP, Wireless Client, WDS-AP and WDS-Client)
SSID	Default: WR322_1 Input the primary name of the access point.
Wireless Mode	Default: 802.11G/N Select the specific wireless mode, different wireless mode has a different configuration. For each wireless mode, it has a specific frequency and it has different basic setting.. <div style="display: flex; align-items: center;"> <div style="margin-right: 10px;">Wireless Mode</div> <div style="border: 1px solid black; padding: 2px;"> 802.11G/N 802.11A Only 802.11B Only 802.11G Only 802.11A/N 802.11G/N 802.11AC </div> </div>
Channel	Default: 2437MHz (6)

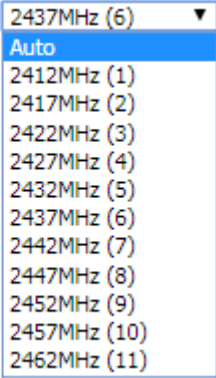
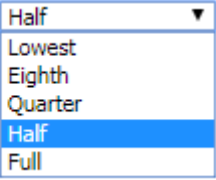
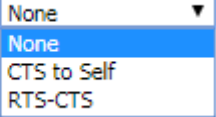
	<p>Select the proper channel, each country has different band user may select the channel based on the situation. Or select auto to automatically set the channel.</p> <p>Channel</p> 
<p>Maximum Output Power</p>	<p>Default: Half</p> <p>Specify the transmission power. For the higher output power, it can cover the signal widely and of course may need big power consumption. The Full output power may need the antenna.</p> <p>Maximum Output Power</p> 
<p>Data Rate</p>	<p>Default: Auto</p> <p>Select the specific data rate in order to control the transmission rate. Auto is preferred rate; the access point will automatically select the highest available rate to transmit. User may select lower rate when there is no great demand for transmission speed, for long distance transmission.</p>
<p>Extension Channel Protection</p>	<p>Extension Channel Protection</p>  <p>Select from the drop down list option between CTS-Self or RTS-CTS to avoid conflict with other wireless network and to improve the ability of the device to catch all the wireless transmissions. By activating this function, it may decrease wireless network performance.</p>

Click **Submit** to apply the configuration

Wireless Site Survey (Wireless Client & WDS-Client)

Click the Site Survey button to open the Wireless Site Survey page. On this page user may choose the Access Point that appeared on the list. After selects the specific AP, then click **Selected** to apply the choice. Click **Scan** to refresh the list.

Select	SSID	Frequency/Channel	MAC Address	Wireless Mode	Signal Strength	Security
<input checked="" type="radio"/>	WOMTEKex(Mobile)	2412MHz(1)	b0:6e:bf:3b:a7:f8	802.11G/N	-29	WPA2
<input type="radio"/>	WOMTEK_Guest	2412MHz(1)	b0:6e:bf:3b:a7:f9	802.11G/N	-29	WPA2
<input type="radio"/>	Cordan1980	2412MHz(1)	f0:f2:49:74:bd:78	802.11G/N	-100	WPA
<input type="radio"/>	WOMTEKex(Mobile)	2437MHz(6)	04:f0:21:3b:8b:6b	802.11G/N	-58	NONE
<input type="radio"/>	ccxzde	2437MHz(6)	04:f0:21:3b:8b:98	802.11G/N	-59	NONE
<input type="radio"/>	ydytdtrd	2437MHz(6)	04:f0:21:3b:8a:4e	802.11G/N	-59	NONE
<input type="radio"/>	00087	2437MHz(6)	06:f0:21:3b:8a:4e	802.11G/N	-59	NONE
<input type="radio"/>	SURGITECH	2437MHz(6)	5c:6a:80:ed:4d:03	802.11G/N	-70	WPA2
<input type="radio"/>	SURGIMED	2437MHz(6)	5e:03:80:ed:4d:04	802.11G/N	-69	WPA2
<input type="radio"/>	WomtekXIndianDoor	2437MHz(6)	12:02:03:04:05:06	802.11G/N	-79	WPA2
<input type="radio"/>	iPhone_Michael	2462MHz(11)	6a:db:ca:7b:7d:df	802.11G/N	-80	WPA2
<input type="radio"/>	Stewv	2462MHz(11)	72:70:0d:27:43:53	802.11G/N	-78	WPA2
<input type="radio"/>	SETUP	2462MHz(11)	c6:cf:4c:fe:30:16	802.11G/N	-61	NONE
<input type="radio"/>	P880	2462MHz(11)	fc:f5:28:71:06:de	802.11G/N	-88	WPA2
<input type="radio"/>	CSC	2437MHz(6)	78:cd:8e:8d:a3:02	802.11G/N	-107	WEP
<input type="radio"/>	tcriB	2432MHz(5)	50:67:f0:60:00:8a	802.11B/G	-89	NONE

The description of the columns is as below:

TERMS	DESCRIPTION
Select	Select the SSID.
SSID	Display the detected SSID's name
Frequency/Channel	Display the current frequency of the AP.
MAC Address	Display the listed AP MAC Address.
Wireless Mode	Display the Wireless mode.
Signal Strength	Display the signal strength
Security	The security mode of the Access Point.

Click **Selected** to connect to the specific SSID.

WDS-AP

The WDS-AP mode usually implements the Point to Point (P2P) connection, so the access point should be WDS-AP and the wireless client should be WDS-Client. So in this case, the AP just can share the connection to the specific wireless client that has its MAC Address. But WDS-AP can be a repeater to provide network access to general clients.

The description of the columns is as below:

TERMS	DESCRIPTION
WLAN Interface	Check the box to disable the WLAN interface and stop all of the wireless function.
Operation Mode	Select the Operation Mode for the router. (AP, Wireless Client, WDS-AP and WDS-Client)
SSID	Default: WR322_1 Input the primary name of the access point.
Broadcast SSID	Default: Enabled. By enabling the broadcast SSID, it makes the AP can be accessed and searched by the clients, and for the security concern by disabling this broadcast SSID, the network will be hidden in order to prevent any malicious attack.
Wireless Mode	Default: 802.11G/N

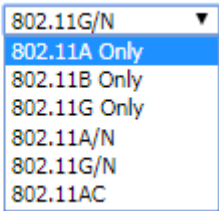
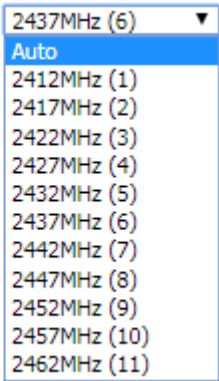
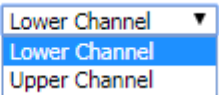
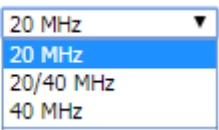
	<p>Select the specific wireless mode, different wireless mode has different configuration. For each wireless mode, it has specific frequency and it has different basic setting.</p> <p>Wireless Mode</p> 
<p>HT Protect</p>	<p>Default: Disabled</p> <p>Select Enabled to activate the High Throughput protect to ensure HT transmission with MAC mechanism.</p>
<p>Channel</p>	<p>Default: 2437MHz (6)</p> <p>Select the proper channel, each country has different band user may select the channel based on the situation. Or select auto to automatically set the channel.</p> <p>Channel</p> 
<p>Extension Channel</p>	<p>Default: Lower Channel 2417MHz (2)</p> <p>Extension Channel</p>  <p>40MHz Center Frequency 2417MHz (2)</p> <p>This option would be appeared when user select the Channel Mode to 20/40MHz or 40MHz. To put range for the frequency, it provides the Lower Channel (2417MHz (2)) with the 40MHz center frequency is 2427MHz (4) and Upper Channel (2457MHz (10)) with the 40MHz center frequency is 2447MHz (8).</p>
<p>Channel Mode</p>	<p>Default: 20MHz</p> <p>Channel Mode</p>  <p>There are three channel modes, 20MHz, 20/40MHz and 40MHz. If user select 20MHz, the frequency that can be received maximum is 20MHz. For</p>

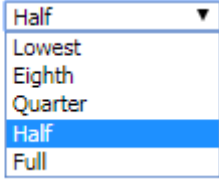
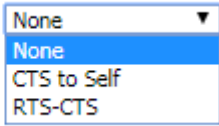
	<p>20/40MHz it can receive both frequency, and for the 40MHz, it provides bigger data rate and received the 40MHz frequency. But basically, if the transmission happened between the AP and the client, both AP and client can have the negotiation phase about the frequency.</p>
Maximum Output Power	<p>Default: Half</p> <p>Specify the transmission power. For the higher output power, it can cover the signal widely and of course may need big power consumption. The Full output power may need the antenna.</p> <p>Maximum Output Power</p> 
Data Rate	<p>Default: Auto</p> <p>Select the specific data rate in order to control the transmission rate. Auto is preferred rate; the access point will automatically select the highest available rate to transmit. User may select the low rate when there is no great demand for transmission speed, for long distance transmission.</p>
Extension Channel Protection	<p>Extension Channel Protection</p>  <p>Select from the dropdown list option between CTS-Self or RTS-CTS to avoid conflict with other wireless network and to improve the ability of the device to catch all the wireless transmissions. By activating this function it may decrease wireless network performance.</p>

Click **Submit** to apply the configuration

WDS-Client

In WDS-Client mode, user must specify the specific WDS-AP's SSID and MAC address. So WDS-Client just do the transmission to the WDS-AP only. In this mode, please make sure that the configuration should be the same as the WDS-AP as well.

The screenshot shows the 'WLAN Setting' configuration page for 'WLAN 1'. The page has several tabs: 'WLAN Status', 'WLAN Setting' (selected), 'WLAN Security', 'Advanced', 'Access Control', and 'Radius Server'. The 'WLAN 1' section contains the following settings:

- WLAN Interface:** Disable
- Operation Mode:** WDS-Client (dropdown menu) with a 'Site Survey' button next to it.
- SSID:** WR322_1
- AP MAC Address:** 00:00:00:00:00:00
- Wireless Mode:** 802.11G/N (dropdown menu)
- Channel Mode:** 20 MHz (dropdown menu)
- Maximum Output Power:** Half (dropdown menu)
- Data Rate:** Auto (dropdown menu)
- Extension Channel Protection:** None (dropdown menu)

At the bottom of the configuration area, there are 'Submit' and 'Cancel' buttons.

The description of the columns is as below:

TERMS	DESCRIPTION
WLAN Interface	Check the box to disable the WLAN interface and stop all of the wireless functions.
Operation Mode	Select the Operation Mode for the router. (AP, Wireless Client, WDS-AP and WDS-Client)
SSID	Default: WR322_1 Input the primary name of the access point.
AP MAC Address	Default: 00:00:00:00:00:00 Set the specific AP MAC Address of the WDS-AP.
Wireless Mode	Default: 802.11G/N Select the specific wireless mode, different wireless mode has a different configuration. For each wireless mode, it has a specific frequency and it has different basic setting.

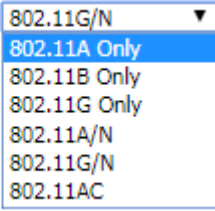
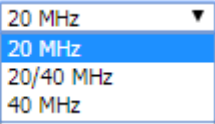
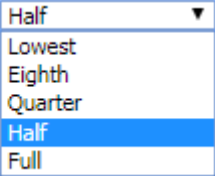
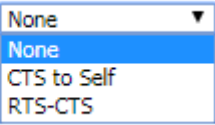
	<p>Wireless Mode</p> 
<p>Channel Mode</p>	<p>Default: 20MHz</p> <p>Channel Mode</p>  <p>There are three channel modes, 20MHz, 20/40MHz and 40MHz. If user select 20MHz, the frequency that can be received maximum is 20MHz. For 20/40MHz it can receive both frequency, and for the 40MHz, it provides bigger data rate and received the 40MHz frequency. But basically, if the transmission happened between the AP and the client, both AP and client can have the negotiation phase about the frequency.</p>
<p>Maximum Output Power</p>	<p>Default: Half</p> <p>Specify the transmission power. For the higher output power, it can cover the signal widely and of course may need big power consumption. The Full output power may need the antenna.</p> <p>Maximum Output Power</p> 
<p>Data Rate</p>	<p>Default: Auto</p> <p>Select the specific data rate in order to control the transmission rate. Auto is preferred rate, the access point will automatically select the highest available rate to transmit. User may select the low rate when there is no great demand for transmission speed, for long distance transmission.</p>
<p>Extension Channel Protection</p>	<p>Extension Channel Protection</p>  <p>Select from the dropdown list option between CTS-Self or RTS-CTS to avoid conflict with other wireless network and to improve the ability of the device to catch all the wireless transmissions. By activate this function it may decrease wireless network performance.</p>

3.7.3 WLAN SECURITY

On this configuration page, user can configure the WLAN Security feature.

WLAN Status
WLAN Setting
WLAN Security
Advanced
Access Control
Radius Server

General Setting

Profile Name

SSID

Broadcast SSID Enable Disable

Wireless Separation Enable Disable

WMM Support Enable Disable

Max. Station Num (0-64)

Security Setting(Setup Radius Server if Radius is enabled!)

Mode

Encryption

Key Type

Default Key

Key 1

Key 2

Key 3

Key 4

The description of the columns is as below:

TERMS	DESCRIPTION
Profile Name	Default: Profile1 Set the profile name for the Access Point.
SSID	Default: WR322_1 Set the Service Set Identifier name, this ID can be recognized by the Client when the WLAN connection is established.
Broadcast SSID	Default: Enabled. By enabling the broadcast SSID, it makes the AP can be accessed and searched by the clients, and for the security concern by disabling this broadcast SSID, the network will be hidden in order to prevent any malicious attack.
Wireless Separation	Default: Disable

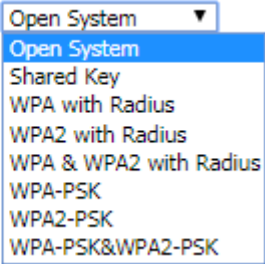
	<p>Under the AP mode, enable it to prevent one wireless device from directly communicating with another on the same AP</p>
<p>WMM Support</p>	<p>Default: Enable</p> <p>A subset of the WLAN specification that enhances quality of service (QoS) on a network by prioritizing data packets onto four categories.</p> <p>Ranging from highest priority to lowest, these categories are:</p> <ul style="list-style-type: none"> ● Voice: Giving voice packets the highest priority enables concurrent Voice over IP (VoIP) calls with minimal latency and the highest quality possible. ● Video: By placing video packets in the second tier, WMM prioritizes it over all other data traffic. ● Best effort: Best effort data packets consist of those originating from legacy devices or from applications or devices that lack QoS standards. ● Background: Background priority encompasses file downloads, print jobs and other traffic that does not suffer from increased latency.
<p>Max Station Number</p>	<p>Default: 64 (0-64)</p> <p>Set the maximum number of station that can communicate with the access point.</p>
<p>Mode</p>	<p>Default: Open System</p> <div style="display: flex; align-items: center; margin-top: 10px;"> <div style="margin-right: 10px;">Mode</div>  </div> <p>Open System: It allows any device to join the network without security checks.</p> <p>Shared Key: Data encryption and key are required for the authentication.</p> <p>WPA with RADIUS: With warrant (username, password and etc.) offered by user, this kind of authentication can be realized with specific RADIUS server.</p> <p>WPA2 with RADIUS: A new version of WPA, only clients that supported with WPA2 can apply this security function. The AES encryption RADIUS server is required.</p> <p>WPA & WPA2 with RADIUS: AES & TKIP encryption and RADIUS server is required.</p> <p>WPA-PSK: A simplified WPA mode that no need to specify the authentication server. It can be called as WPA Pre-Shared Key, a user just</p>

	<p>needs to enter a key in each WLAN node. The data encryption can only TKIP.</p> <p>WPA2-PSK: A new version of WPA, only clients that supported with WPA2 can apply this security function. The data encryption can only be AES and WPA Pre-Share Key is required.</p> <p>WPA-PSK&WPA2-PSK: The data encryption will be AES & TKIP and WPA Pre-Share Key is required.</p>
Encryption	<p>Configure the data encryption mode.</p> <ul style="list-style-type: none"> ● None: Available only when the authentication type is an open system. ● 64 bits WEP: It is made up of 10 hexadecimal numbers. ● 128 bits WEP: It is made up of 26 hexadecimal numbers. ● TKIP: Temporal Key Integrity Protocol, which is a kind of dynamic encryption, is co-used with WPA-PSK. ● AES: Advanced Encryption Standard, it is usually co-used with WPA2-PSK.
Key Type	<p>Default: Hex</p> <p>WEP can be configured with a 64-bit or 128-bit Shared Key (hexadecimal or ASCII). As defined, hexadecimal number is represented by 0-9, A-F or a-f; ASCII is represented by 0-9, A-F, a-f or punctuation. Each one consists of two-digit hexadecimal.</p>
Default Key	<p>Default: Key 1</p> <p>Set the specific default key.</p>
Key 1~4	<p>Enter the specific encryption key.</p>

3.7.4 ADVANCED

The page allows the advanced user to configure advanced wireless setting with more experience about the WLAN. If user doesn't have any qualified knowledge about WLAN, we suggest not to change the default setting except user know what is the effect when the setting is changed. The wrong configuration may impact the performance of wireless network.

WLAN Status
WLAN Setting
WLAN Security
Advanced
Access Control
Radius Server

WLAN Advanced Setting

A-MPDU aggregation Enable Disable

A-MSDU aggregation Enable Disable

Short GI Enable Disable

RTS Threshold (1-2347)

Fragment Threshold (256-2346)

Beacon Interval (20-1024 ms)

DTIM Interval (1-255)

Preamble Type Long Auto

IGMP Snooping Enable Disable

Antenna Number ▼

The description of the columns is as below:

TERMS	DESCRIPTION
A-MPDU/A-MSDU aggregation	For the AP mode, by enabling this function the data rate of the AP could be enhanced greatly, Do not enable this function if the wireless clients don't support A-MPDU/A-MSDU aggregation.
Short GI	Enable this function to obtain better data rate. (careful with compatibility issue)
RTS Threshold	Default: 2347 (1-2347) Basically, it is about the transmission process between the AP and the end station. When the AP sends Request to Send frames to station and it will do the negotiation process about sending the data frame. When the station receives an RTS frame, the station will respond with send back Clear to Send frame to confirm the right to start transmission.
Fragment Threshold	Default: 2346 (256-2436) Specify the maximum size in byte for a packet before data is fragmented into multiple packets. Setting it too low may result in poor network performance.

Beacon Interval	Default: 100ms (20-1024 ms) Specify the interval to broadcast packets.
DTIM Interval	Default: 1 (1-255) Delivery Traffic Indication Message interval is an additional message added after the beacon interval broadcast by access point. It is for enhancing the wireless transmission efficiency. The more intervals we added, the more power that we need. By setting a low value of DTIM, user can effectively keep the devices awake indefinitely so they never go into sleep mode when idling.
Preamble Type	Default: Long Preamble Type setting means that it adds some additional data header strings to help check the Wi-Fi data transmission errors. Basically, preamble type divided into two, long and short. Short is for shorter data strings that adds less data to transmit the error redundancy check which means that it is much faster. Long Preamble Type uses longer data strings which allow for better error checking capability. Auto Preamble Type the device can set the Preamble Type Automatically according to the need, which is can be long or can be short.
IGMP Snooping	Default: Enable By enabling IGMP Snooping allows the ports to detect IGMP queries, report packets, and manage multicast traffic through the AP. IGMP Snooping provides the ability to prune multicast traffic so that it travels only to those end destinations that require that traffic.
Antenna Number	Default: Two Antenna The Antenna Number setting allows user to choose the antenna that used in the wireless connection. Basically, the default setting is set to Two antennas, because the device itself provide two antenna sockets. User can configure One Antenna or Two Antenna. Please refer to the Antenna Placement table to connect the antenna correctly.

3.7.5 ACCESS CONTROL (AP MODE)

This page allows user configure the Wireless Access Control list. User can add the rule to Allow list or Deny list for the security concern to access WLAN.

WLAN Status
WLAN Setting
WLAN Security
Advanced
Access Control
Radius Server

WLAN Access Control

Access Control Mode Allow Listed ▼

MAC Address

Submit
Cancel

MAC Address	Select	Edit
78:02:f8:3f:ad:53	<input type="checkbox"/>	Edit

Delete Selected
Delete All
Reload

The description of the columns is as below:

TERMS	DESCRIPTION
Access Control Mode	Default: Disable Allow List – Allow the specific MAC Address to access the WLAN Deny List – Deny the specific MAC Address to access the WLAN
MAC Address	Display the specific MAC Address that allowed or denied to access the WLAN.
Select	Select the MAC Address list.
Edit	Click to edit the Access Control Mode for the specific MAC Address

3.7.6 RADIUS SERVER (AP MODE)

The Remote Authentication Dial In User Service (RADIUS) mechanism is a centralized “AAA” (Authentication, Authorization, and Accounting) system for connecting to network services. The fundamental purpose of RADIUS is to provide an efficient and secure mechanism for user account management. The RADIUS server system allows you to access the router through secure networks against unauthorized access.

The screenshot shows the 'Radius Server Setting' configuration page. It features a navigation bar with tabs for 'WLAN Status', 'WLAN Setting', 'WLAN Security', 'Advanced', 'Access Control', and 'Radius Server'. The 'Radius Server' tab is selected. The main content area is titled 'Radius Server Setting' and contains a 'General Setting' section. This section includes three input fields: 'IP Address' (set to 0.0.0.0), 'Port' (set to 1812), and 'Shared Secret' (empty). Below the input fields are 'Submit' and 'Cancel' buttons.

How to set up a RADIUS server:

- a. Enter the IP address of the RADIUS server in **Server IP Address**
- b. Enter the **Shared Secret** of the RADIUS server
- c. Enter the **Server port** if necessary, by default RADIUS server listens to port 1812
- d. Click **Submit**

The description of the RADIUS Authentication interface is as below:

TERMS	DESCRIPTION
IP Address	Radius Server IP Address
Server Port	Set communication port on an external RADIUS server as the authentication database. The default value is 1812
Shared Key	Shared key is used to verify that RADIUS messages, with the exception of the Access-Request message, are sent by a RADIUS-enabled device that is configured with the same shared key. Shared key also verifies that the RADIUS message has not been modified in transit (message integrity).

3.7.7 CERTIFICATE FILE (CLIENT MODE)

Using digital certificates for authentication method through the RADIUS that provided by the AP. User needs to upload the specific certificate file, so then the client can access the Wi-Fi connection.

WLAN Certificate Setting

Delete User Key

Upload User Key No file chosen

The description of the columns is as below:

TERMS	DESCRIPTION
Delete User Key	Delete the selected certificate
Upload User Key	Upload a certificate file from a specified file location

3.7.8 AUTO OFFLOAD (CLIENT MODE)

The WoMaster Router Client mode is supported by the Auto Offload feature that allows the user to enable Wireless Auto Offload. User need to make sure if the device has two available connections, Wi-Fi and Cellular. The cellular cost can be reduced by using this feature because the data traffic can be shared by Cellular and Wi-Fi. If the Wi-Fi signal is poor, then the system forwards the traffic to the Cellular interface automatically.

WLAN Status
WLAN Setting
WLAN Security
Advanced
Certificate File
Auto offload

WLAN Auto Offload Setting

Auto Offload Enable Disable (Current signal: -44 dBm)

Signal low-threshold dBm (-1 ~ -100)

Signal high-threshold dBm (-1 ~ -100)

Switch mode Auto Once

Active Path

Default Gateway

The description of the interface is as below:

TERMS	DESCRIPTION
Auto Offload	<p>Default: Disable</p> <p>Enable or Disable Auto Offload feature. This feature can be activated when the Wi-Fi is configured as the client mode and the Cellular interface is established. And it will show the current signal strength.</p>
Signal low-threshold	<p>Default: -80 dBm (Range: -1 ~ -100 dBm)</p> <p>When signal strength is lower than the upper range, then the connection will be directed to Cellular.</p>
Signal high-threshold	<p>Default: -50 dBm (Range: -1 ~ -100 dBm)</p> <p>When signal strength is higher than the upper range, then the connection will be directed to Wi-Fi.</p>
Switch mode	<p>Default: Auto</p> <p>When user chooses the Auto mode, the connection will automatically switch to the stronger signal between Wi-Fi or Cellular. If user chooses to Once mode, it means the connection will switch to the stronger signal once between Wi-Fi or Cellular and will stay at the connection even there were a stronger signal appear.</p>
Active Path	<p>Show the current active path between Wireless or Cellular.</p>
Default Gateway	<p>Show the default gateway IP Address.</p>

3.8 SECURITY

WoMaster Router provides several security features for User to secure access to its management functions and it can be remotely managed (monitored and configured).

The following topics are included in this section:

3.8.1 Access Control

3.8.2 Outbound Firewall

3.8.3 NAT Setting

3.8.4 OpenVPN

3.8.5 IPSec Setting

3.8.6 GRE Setting

3.8.1 ACCESS CONTROL

WoMaster router provides access control mode in several ways, such as Remote Management, WAN Service Access Control and Custom Exception. By configuring this configuration, user can enhance the security access to the device.

Remote Management

Remote Management function, open the Remote Management, that would allow the user via the local access (WAN Port) Remote Management the router.

Remote Management

Service	Enable
Telnet	<input checked="" type="checkbox"/> Enable
SNMP	<input checked="" type="checkbox"/> Enable
SSH	<input type="checkbox"/> Enable
HTTPS Only	<input type="checkbox"/> Enable

The description of the columns is as below:

TERMS	DESCRIPTION
Telnet	Allows the user to remotely login and manage the device by Telnet. When user doesn't enable it, the connection through telnet will not allow.
SNMP	Allows the user to remotely login and manage the device by SNMP. When user doesn't enable it, the connection through SNMP will not allow.
SSH	Allows the user to remotely login and manage the device by SSH/ When user doesn't enable it, the connection through SSH will not allow.
HTTPS Only	Allows the user to remotely login and manage the device by HTTPS access for secure connection, and it would disable the HTTP access.

Once User finishes configuring the settings, click on **Submit** to apply configuration.

HTTPS Only

HTTP Secure is the use of the HTTP protocol over an SSL/TLS protocol. It is used primarily to protect against eavesdropping of communication between a web browser and the web site to which it is connected. This is especially important when you wish to have a secure connection over a public network such as the internet. HTTPS connections are secured through the use of certificates issued by trusted certificate authorities. When a web browser makes a connection attempt to a secured web site, a digital certificate is sent to the browser so that it can verify the authenticity of the site using a built-in list of trusted certificate authorities.

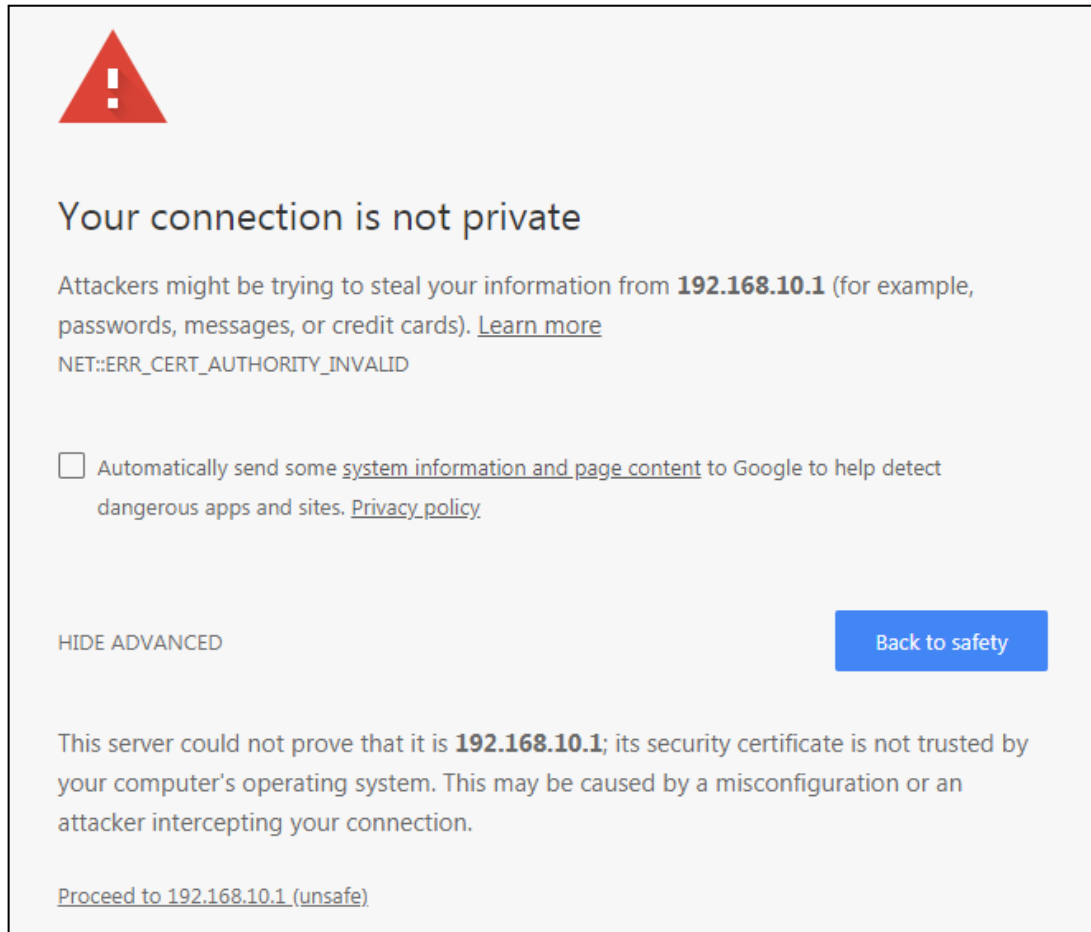



Your connection is not private

Attackers might be trying to steal your information from **192.168.10.1** (for example, passwords, messages, or credit cards). [Learn more](#)

NET::ERR_CERT_AUTHORITY_INVALID

Automatically send some [system information and page content](#) to Google to help detect dangerous apps and sites. [Privacy policy](#)

HIDE ADVANCED Back to safety

This server could not prove that it is **192.168.10.1**; its security certificate is not trusted by your computer's operating system. This may be caused by a misconfiguration or an attacker intercepting your connection.

[Proceed to 192.168.10.1 \(unsafe\)](#)

If user uses the HTTPS Only, a warning page would appear when user access the device in order to provide a secure access. The picture above is the warning message about the digital certificate and user just need to accept this warning by click "**Proceed to 192.168.10.1 (unsafe)**".

WAN Access

When user changes the device mode to **router mode (Port 1 – WAN interface)** the WAN Access feature can be activated. This feature is about the exception to access the device through the WAN interface for security concern. So that the access or the traffic that coming through the WAN interface can be limited as required. The user may choose the **Filter All** functions to block all access from the WAN interface or enable the exception options, then the router allows user to remotely access to the router from WAN interface.

Service	(W)WAN (Exception)
Web	<input type="checkbox"/> Enable
Telnet	<input type="checkbox"/> Enable
SSH	<input type="checkbox"/> Enable
SNMP	<input type="checkbox"/> Enable

The description of the columns is as below:

TERMS	DESCRIPTION
Filter All	By select Filter All, it will block all external access from WAN interface to the device (such as SSH, SNMP, Web and Telnet) and unblock the exception options.
Web	Select this option to allow access to the router using Web (HTTP or HTTPS) from the WAN Interface
Telnet	Select this option to allow access to the router using Telnet from the WAN Interface
SSH	Select this option to allow access to the router using SSH from the WAN Interface
SNMP	Select this option to allow access to the router using SNMP from the WAN Interface

Once User finishes configuring the settings, click on **Submit** to apply configuration.

Custom Exception

Another choice for the access control is also provided by WoMaster, it is called custom exception feature. Through this feature, it can help to allow the incoming access through the firewall to local devices. If the condition does not meet the requirement from the table, then the access would be denied.

Access Control ▾ | Outbound Firewall ▾ | NAT Setting ▾ | OpenVPN ▾ | IPsec Setting

Custom Exception

Incoming IP Address:

Src Port Range: -

Dest Port Range: -

Comment:

Src IP Address ↕	Src Port Range ↕	Dest Port Range ↕	Comment ↕	Select	Edit
192.168.10.2	1-2	1-10		<input type="checkbox"/>	<input type="button" value="Edit"/>

The description of the columns is as below:

TERMS	DESCRIPTION
Src IP Address	Set up the source IP Address that may access the device.
Src Port Range	Set up the source port range where the access came from.
Dest Port Range	Set up the destination port range where the access is going to.
Comment	Put any notes for the entry.
Select	Select the table, so user can press Delete Selected to delete,
Edit	Click edit to modify the parameters

Once User finishes configuring the settings, click on **Submit** to apply configuration and a new line will directly appear on the table.

3.8.2 OUTBOUND FIREWALL

WoMaster' router has different types firewall settings, user can enable the setting, configure the rules. The following section is Outbound Firewall Settings pages where user can configure the Outbound Firewall setting.

TERMS	DESCRIPTION
Source IP Filter	Source IP addresses Filtering from LAN to Internet through the router.
Destination IP Filter	Destination IP addresses Filtering from the LAN to Internet through the router.
Source Port Filtering	Source Ports Filtering from the LAN to Internet through the router.
Destination Port Filtering	Destination Ports Filtering from the LAN to Internet through the router

Src IP Filter

By entries parameter in this table, it can restrict certain types of data packets from the local network to the internet through the Router. The Source IP Filter will help to filter all of the packets that coming into the router. If the source IP is on the list, then the packets would be dropped. But if the source IP is not on the list, then the packets can be received. Select **Enable** to activate **Source IP Filtering**, type the **Local IP Address** and **Comment** to write notes for the entry. Click Submit to activate the settings. After applied, then user can see the new entry shown in the below table.

Access Control ▾
Outbound Firewall ▾
NAT Setting ▾
OpenVPN ▾
IPSec Setting

Source IP Filter

Source IP Filter: Enable

Local IP Address:

Comment:

Local IP Address	Comment	Select	Edit
192.168.10.4		<input type="checkbox"/>	<input type="button" value="Edit"/>

The description of the columns is as below:

TERMS	DESCRIPTION
Local IP Address	Display the Source IP address.
Comment	Put any notes for the entry.
Select	Select the table, so user can press Delete Selected to delete,
Edit	Click edit to modify the parameters

Click **Refresh** to refresh the table

Dest IP Filter

By entries parameters in this table are used to restrict the computers in LAN from accessing certain websites in WAN according to IP address. The concept is the same as the source IP Filter. The packet would not send to the specific IP Address that showed on the list. Only the IP Address that shows on the list that cannot receive the packets. Select **Enable** to activate **Destination IP Filtering**, type the **Destination IP Address** and **Comment** to write a note for the entry and then click Submit to apply the settings. After applied, then user can see the new entry shown in the below table.

Access Control ▾ **Outbound Firewall ▾** NAT Setting ▾ OpenVPN ▾ IPsec Setting

Destination IP Filter

Destination IP Filter: Enable

Destination IP Address:

Comment:

Destination IP Address	Comment	Select	Edit
192.168.10.3	<input type="text"/>	<input type="checkbox"/>	<input type="button" value="Edit"/>

The description of the columns is as below:

TERMS	DESCRIPTION
Destination IP Address	Display the Destination IP address.
Comment	Put any notes for the entry.
Select	Select the table, so user can press Delete Selected to delete,
Edit	Click edit to modify the parameters

Click **Refresh** to refresh the table

Src Port Filter

Entries in this table are used to restrict certain ports of data packets from user's local network to the Internet through the Router. Use of such filters can be helpful in securing or restricting local network. The device just cannot receive any packets from the source port that showed on the list, the other packet that sent from any source port that not on the list would be received.

Select **Enable Source Port filtering**, type the **Port Range** of below **Protocol** type, the protocol type can be **UDP, TCP or Both**. Type the **Comment** to write a note for the entry and then click **Submit** to activate the settings.

After applied, user can see the new entry shown in the below table.

Access Control ▾ | Outbound Firewall ▾ | NAT Setting ▾ | OpenVPN ▾ | IPsec Setting

Source Port Filter

Source Port Filter: Enable

Port Range: -

Protocol:

Comment:

Source Port Range	Protocol	Comment	Select	Edit
1-10	TCP+UDP		<input type="checkbox"/>	<input type="button" value="Edit"/>

The description of the columns is as below:

TERMS	DESCRIPTION
Source Port Range	Display the Source Port Range (Range is from 1 to 65535)
Protocol	Display the protocol that has been chosen by the user.
Comment	Put any notes for the entry.
Select	Select the table, so user can press Delete Selected to delete,
Edit	Click edit to modify the parameters

Click **Refresh** to refresh the table

Dest Port Filter

Entries in this table are used to restrict certain ports of data packets from user's local network to Internet through the router. Use of such filters can be helpful in securing or restricting local network. And the device cannot send any packets to the destination port that showed on the list.

Select **Enable Destination Port Filtering**, type the **Port Range** of below **Protocol** type, the protocol type can be **UDP, TCP or Both**. Type the **Comment** to write note for the entry and then press **Submit** to apply the settings.

After applied, then user can see the new entry shown in the below table.

Access Control ▾
Outbound Firewall ▾
NAT Setting ▾
OpenVPN ▾
IPSec Setting

Destination Port Filter

Destination Port Filter: Enable

Port Range: -

Protocol: Both ▾

Comment:

Submit
Cancel

Dest Port Range ↕	Protocol ↕	Comment ↕	Select	Edit
1-10	TCP+UDP		<input type="checkbox"/>	Edit

Delete Selected
Delete All
Refresh

The description of the columns is as below:

TERMS	DESCRIPTION
Dest Port Range	Display the Destination Port Range (Range is from 1 to 65535)
Protocol	Display the protocol that has been chosen by the user.
Comment	Put any notes for the entry.
Select	Select the table, so user can press Delete Selected to delete,
Edit	Click edit to modify the parameters

Click **Refresh** to refresh the table

3.8.3 NAT SETTING

Network Address Translation is the process where a network device, usually a firewall, assigns a public address to a device or group of devices inside a private network. The main use of NAT is to limit the number of public IP addresses an organization or company must use, for both economic and security purposes. The simple type of NAT provides one to one translation of IP address. It can be used to interconnect two IP networks, normally one network is for Local Area Network and the other network is for Wide Area Network/Internet. To support this function, there are two ways to do it, by using Source Network Address Translation (SNAT), Destination Network Address Translation (DNAT). Basically, Network Address Translation (NAT) occurs when one of the IP addresses in an IP packet header is changed. In a SNAT, the destination IP address is maintained and the source IP address is changed. Most commonly, a SNAT allows a host on the “inside” of the NAT, in an RFC 1918 IP address space, to initiate a connection to a host on the “outside” of the NAT. It supports the Port Forwarding, DMZ and 1 to 1 NAT configuration. A DNAT, by way of contrast, occurs when the destination address is changed and the source IP address is maintained. A DNAT allows a host on the “outside” to connect to a host on the “inside”. In both cases, the NAT has to maintain a connection table which tells the NAT where to route returning packets. An important difference between a SNAT and a DNAT is that a SNAT allows multiple hosts on the “inside” to get to any host on the “outside”. By way of contrast, a DNAT allows any host on the “outside” to get to a single host on the “inside”. It is supported in NAPT and 1 to 1 NAT features. To configure the NAT Setting, the **Port Forwarding, DMZ, Port Mapping Policy and 1 to 1 NAT** configuration page are provided in this section.

Port Forwarding

Port Forwarding

Port Forwarding Enable

Public Port Range: -

IP Address:

Protocol:

Port Range: -

Comment:

Public Port Range	Local IP Address	Protocol	Port Range	Comment	Select	Edit
-------------------	------------------	----------	------------	---------	--------	------

By configuring this table, it allows user to automatically redirect common network services to a specific machine behind the NAT firewall. Select **Enable** to activate **Port Forwarding** function and then input all of the parameters to configure the port forwarding.

The description of the columns is as below:

TERMS	DESCRIPTION
Port Forwarding	Select Enable to activate Port Forwarding function.
Public Port Range	Configure the port range, which will be public to a WAN / Internet. User can configure one or a range of TCP/UDP port number.
IP Address	Configure the IP Address of the LAN PC. The traffic from the public port range will be redirected to this IP address.
Protocol	Configure TCP, UDP or Both (TCP + UDP) protocol type.
Port Range	Configure the port range of the LAN; the traffic from the public port will be redirected to these ports.
Comment	Add information to the entry.

Once User finishes configuring the settings, click on **Submit** to apply User configuration.

DMZ

A **Demilitarized Zone** is used to provide Internet services without sacrificing unauthorized access to its local private network. Typically, the DMZ host contains device accessible to Internet traffic, such as Web (HTTP) servers, FTP servers, SMTP (e-mail) servers and DNS servers.

DMZ

DMZ: Enable

DMZ Host IP Address:

Click **Enable** to activate the function and assign the IP address of **DMZ Host IP Address**. This is the DMZ computer's IP address. Click Submit to activate the function.

The description of the columns is as below:

TERMS	DESCRIPTION
DMZ	Select Enable to activate DMZ function.
DMZ Host IP Address	Configure the port range, which will be public to a WAN / Internet. User can configure one or a range of TCP/UDP port number.

Port Mapping Policy

This page allows user to configure the Port Mapping policy from NAT Setting.

Port Mapping Policy

Port Mapping Policy

The description of the columns is as below:

TERMS	DESCRIPTION
Port Mapping Policy	<p>Default: Reuse</p> <p>Reuse: Use the same port number that has been used to access the same remote device.</p> <p>Randomize: Change the port number every time access the remote device.</p>

Click **Submit** to apply the configuration.

1 to 1 NAT

One-to-one NAT is a way to make systems behind a firewall and configured with private IP addresses (those reserved for private use in RFC 1918) appear to have public IP addresses. With one-to-one NAT, you assign local systems RFC 1918 addresses then establish a one-to-one mapping between those addresses and public IP addresses. For outgoing connections SNAT (Source Network Address Translation) occurs and on incoming connections DNAT (Destination Network Address Translation) occurs. Below is the 1 to 1 NAT section interface.

1 to 1 NAT

1 to 1 NAT Enable

Local IP Address

WAN IP Address

Comment

Local IP	WAN IP	Comment	Select	Edit
192.168.10.1	192.168.1.1	Main Server	<input type="checkbox"/>	<input type="button" value="Edit"/>

The description of the columns is as below:

TERMS	DESCRIPTION
1 to 1 NAT	Check the box to enable the function
Local IP Address	The target local IP Address
WAN IP Address	The incoming IP Address that coming through the WAN
Comment	Enter a comment

Click **Submit** to apply the configuration.

3.8.4 OPEN VPN

WoMaster router supports OpenVPN. It implements virtual private network (VPN) techniques for creating secure point-to-point or site-to-site connections. It is possible to create one-to-many tunnel for the VPN Server. OpenVPN implementation offers a cost-effective, simply configurable alternative to other VPN technologies. OpenVPN allows peers to authenticate each other using a pre-shared secret key, certificates, or username/password. The server and client have almost the same configuration. The difference in the client configuration is the remote endpoint IP or hostname field. Also, the client can set up the keepalive settings.

OpenVPN Status

This section shows the VPN Client and Server current status.

Access Control ▾ | Outbound Firewall ▾ | NAT Setting ▾ | OpenVPN ▾ | IPsec Setting

OpenVPN Status

OpenVPN

Client Status

Enabled

Connection Status

Server Status

Enabled

[Refresh](#)

The description of the columns is as below:

TERMS	DESCRIPTION
Enabled	Default: no yes: The VPN function is enabled. no: The VPN function is not enabled
Connection Status	Default: Disconnected Connected: The VPN connection is established Disconnected: The VPN connection is not established

Click **Refresh** to update the information.

OpenVPN Client

This page is about the OpenVPN Client configuration page. While the device set as the VPN client, the parameters must follow the VPN Server settings. User should adjust the parameters with the administrator of the VPN server to entry the correct parameters. Two VPN servers IP are also provided in order to have the backup connection for VPN Server.

Access Control ▾
Outbound Firewall ▾
NAT Setting ▾
OpenVPN ▾
IPSec Setting

OpenVPN Client

Enable VPN Client : Enable

Encryption Mode : Static TLS

Server 1 : (IP or Domain Name)

Server 2 :

Port : (1-65535)

Tunnel Protocol :

Encryption Cipher :

Hash Algorithm :

ping-timer-rem : Enable Disable

persist-tun : Enable Disable

persist-key : Enable Disable

LZO Compression : Enable Disable

Keepalive : Enable Disable

Ping Interval : (1-99999 seconds)

Retry Timeout : (1-99999 seconds)

nobind :

ifconfig : Local : Remote :

Route : IP : MASK :

Save Log File :

The description of the columns is as below:

TERMS	DESCRIPTION
Enable VPN Client	Select Enable to activate the VPN Client function
Encryption Mode	Choose the Encryption Mode Static Key: Use a pre-shared static key. TLS: Use SSL/TLS + certificates for authentication and key exchange.
Server 1	Type the IP Address of the VPN Server
Server 2	Type the second IP Address of the VPN Server if needed.

Port	Default: 1194 Input the port number that VPN service used. Please check the VPN Server port setting. The range from 1-65535.
Tunnel Protocol	Choose use TCP or UDP to establish the VPN connection.
Encryption Cipher	Select the encryption cipher from Blowfish to AES in Pull-down menus.
Hash Algorithm	Hash algorithm provides a method of quick access to data, including SHA1 , SHA256 , SHA512 , MD5
ping-timer-rem	Default: Enable Select enable or disable the ping-timer-rem, this function prevent unnecessary restart at server/client when network fail.
persist-tun	Default: Enable Select enable or disable the persist-tun, enable this function will keep tun(layer 3) device linkup after Keepalive timeout.
persist-key	Default: Enable Select enable or disable the persist-key, enable this function will keep the key first use if VPN restart after Keepalive timeout.
LZO Compression	Default: Disable Select use LZO Compression or not, this function compresses data to decrease the traffic but also need more CPU effort.
Keepalive	Default: Enable Select enable or disable Keepalive function, this function is use to detect the status of connection.
Ping Interval	Default: 10 Input the ping interval, the range can from 1~99999 seconds.
Retry Timeout	Default: 60 Input the retry timeout, the range can from 1~99999 seconds.
nobind	Check the box to activate nobind function. With nobind function, the source ports are random.
ifconfig	Input the tunnel IP addresses that VPN use.
Route	Input the route IP and MASK. This is the target IP domain that user can access through the VPN tunnel.
Save Log File	Click Save to keep the VPN Client Log.

Click **Submit** to apply the configuration.

OpenVPN Server

To help user create the One to One Secure connection for the remote devices, WoMaster device supports both OpenVPN Server and OpenVPN Client. This Server setting allows user to configure the Secure M2M connection for one remote Client. But WoMaster router also supports one to multiple for VPN Client.

Access Control ▾
Outbound Firewall ▾
NAT Setting ▾
OpenVPN ▾
IPSec Setting

OpenVPN Server

Enable VPN Server Enable

Encryption Mode : Static TLS

Port : (1-65535)

Tunnel Protocol : ▾

Encryption Cipher : ▾

Hash Algorithm : ▾

ping-timer-rem : Enable Disable

persist-tun : Enable Disable

persist-key : Enable Disable

Use LZO Compression : Enable Disable

Keepalive : Enable Disable

Ping Interval : (1-99999 seconds)

Retry Timeout : (1-99999 seconds)

ifconfig : Local : Remote :

Route : IP : MASK :

Save Log File :

The description of the columns is as below:

TERMS	DESCRIPTION
Enable VPN Server	Select Enable to activate the VPN Server function
Encryption Mode	Choose the Encryption Mode Static Key: Use a pre-shared static key. TLS: Use SSL/TLS + certificates for authentication and key exchange.
Server 1	Type the IP Address of the VPN Server
Server 2	Type the second IP Address of the VPN Server if needed.
Port	Default: 1194 Input the port number that VPN service used. Please check the VPN Server port setting. The range from 1-65535.

Tunnel Protocol	Choose use TCP or UDP to establish the VPN connection.
Encryption Cipher	Select the encryption cipher from Blowfish to AES in Pull-down menus.
Hash Algorithm	Hash algorithm provides a method of quick access to data, including SHA1, SHA256, SHA512, and MD5
ping-timer-rem	Default: Enable Select enable or disable the ping-timer-rem, this function is to prevent unnecessary restart at server/client when the network fails.
persist-tun	Default: Enable Select enable or disable the persist-tun, enable this function will keep tun(layer 3) device linkup after Keepalive timeout.
persist-key	Default: Enable Select enable or disable the persist-key, enable this function will keep the key first use if VPN restart after Keepalive timeout.
LZO Compression	Default: Disable Select use LZO Compression or not, this function compresses data to decrease the traffic, but also need more CPU effort.
Keepalive	Default: Enable Select enable or disable Keepalive function, this function is used to detect the status of the connection.
Ping Interval	Input the ping interval, the range can from 1~99999 seconds.
Retry Timeout	Input the retry timeout, the range can from 1~99999 seconds.
ifconfig	Input the tunnel IP addresses that VPN use.
Route	Input the route IP and MASK. This is the target IP domain that user can access through the VPN tunnel.
Save Log File	Click Save to keep the VPN Server Log.

Click **Submit** to apply the configuration.

OpenVPN Certificate

Using digital certificates for authentication instead of preshared keys in VPNs is considered more secure. In WoMaster' devices, digital certificates are one way of authenticating two peer devices to establish a VPN tunnel.

Access Control ▾ | Outbound Firewall ▾ | NAT Setting ▾ | OpenVPN ▾ | IPsec Setting

VPN Key Management

Delete VPN Key: ▾

Upload VPN Key: No file chosen

The description of the columns is as below:

TERMS	DESCRIPTION
Delete VPN Key	Delete the selected certificate
Upload VPN Key	Upload a certificate file from a specified file location

3.8.5 IPSEC SETTING

Internet Protocol Security (IPsec) is a protocol suite for securing Internet Protocol (IP) communications by authenticating and encrypting each IP packet of a communication session. By configure this configuration page, user allows IPsec tunnels to pass through the router.

Access Control ▾
Outbound Firewall ▾
NAT Setting ▾
OpenVPN ▾
IPSec Setting

IPsec Settings

Enable IPsec Enable

IPsec Status Disconnected

Authentication Method : PSK ▾

Pre-shared Key : 12345678 (max. length 25)

IPsec Cipher Suites : AES128-SHA1-DH: ▾
(algorithms for ike and esp proposal)

Local IP : 0.0.0.0
(use 0.0.0.0 when wan is dynamic ip.)

Local Subnet : ex : 192.168.10.0/24 (Network/Netmask)

Remote Host : 0.0.0.0
(use 0.0.0.0 if remote is dynamic ip.)

Remote Subnet : ex : 192.168.20.0/24 (Network/Netmask)

The description of the columns is as below:

TERMS	DESCRIPTION
Enable IPsec	Select Enable to activate the IPsec function
IPsec Status	Display the IPsec status, whether it is connected or disconnected
Authentication Method	Default: PSK Optional: Pre Shared Key or Certificate
Pre-shared key	Default: 12345678 Set the preshared key
IPsec Cipher Suites	Default: AES128-SHA1-DH2 Set algorithms for IKE and ESP proposal, choose AES128-SHA1-DH2, DES-SHA1-DH2 and 3DES-SHA1-DH2
Local IP	IP Address of the local side of the tunnel. (Use 0.0.0.0 when WAN is dynamic IP.)
Local Subnet	Set IPsec local protected subnet and subnet mask, i.e. 192.168.1.0/24
Remote Host	Default: 0.0.0.0 Set IPsec Remote Host, use the default setting if remote is dynamic IP
Remote Subnet	Set IPsec Remote Protected Subnet/Subnet Netmask

Click **Submit** to apply the configuration.

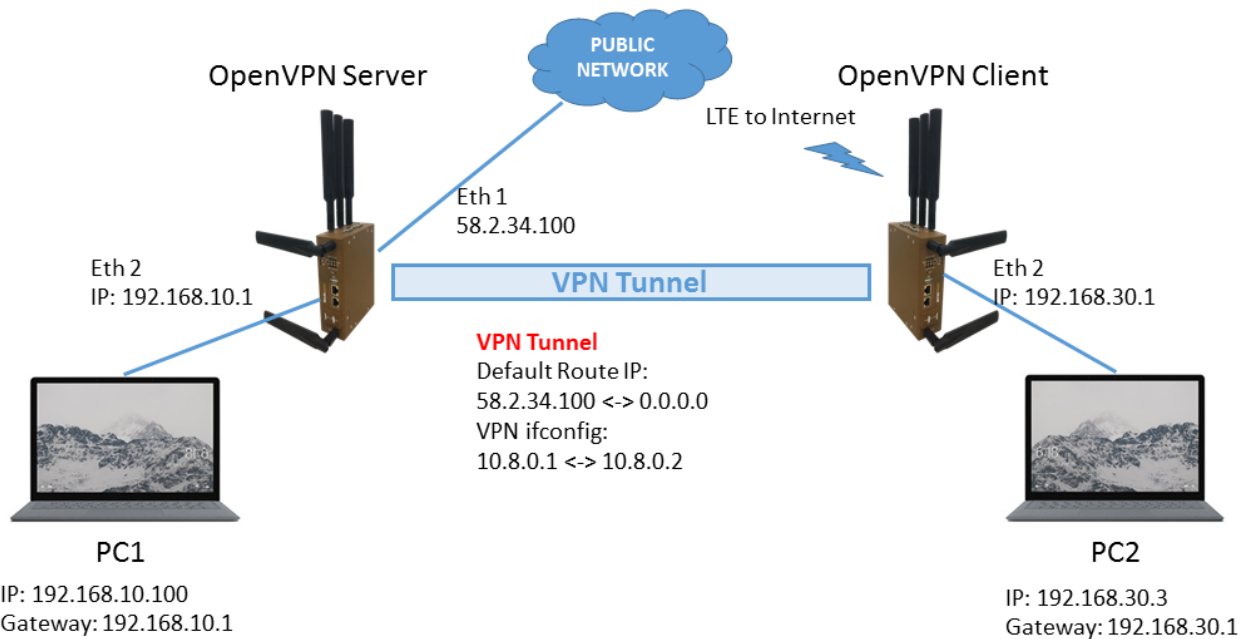

The topology above is about how the branch office can get the access to the headquarter server. The two laptops are connected to the device using the Ethernet cable.

The laptop at the branch office picks a role as the VPN Client and the laptop at headquarter picks a role as the VPN Server. To get the access to the server the branch office need to connect to the VPN Server. As we can see the connection is established through the LTE connection. In this case, IPsec connection needs to be enabled. See the setting below.

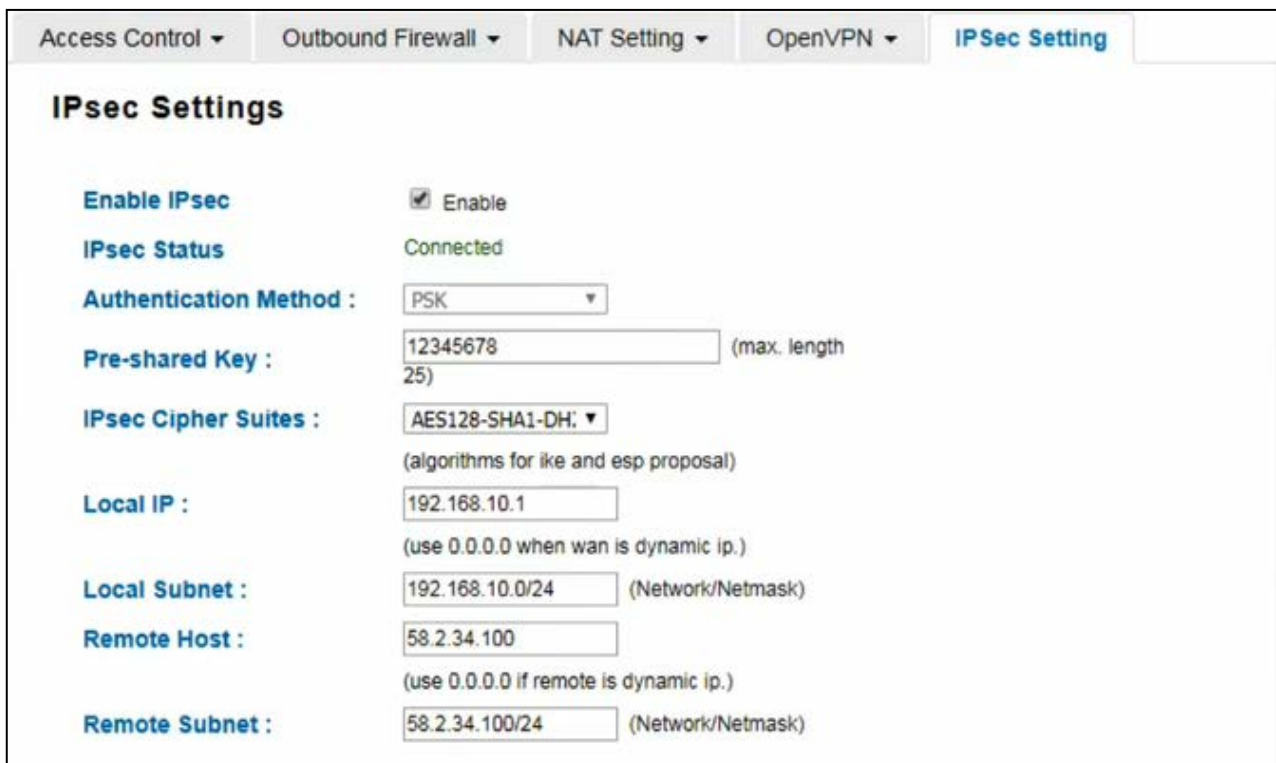

When the connection is enabled, then the IPsec status will directly change to connected status, which means that the connection is established. So that the laptop at the branch office can access the server at headquarter.

3.8.6 GRE SETTING

GRE (Generic Routing Encapsulation RFC2784) is a solution for tunneling RFC1812 private address-space traffic over an intermediate TCP/IP network such as the Internet. GRE tunneling does not use encryption it simply encapsulates data and sends it over the WAN port only. This page allows user to set up GRE tunnels and view information about the amount of data transmitted and received.

GRE Setting

GRE Enable

Remote IP Address

Virtual Remote IP Address

Virtual Local IP Address

Virtual Local Subnet Mask

Tunnel Route

(use 0.0.0.0 if route is default route.)

Tunnel Route Subnet Mask

Key

Comment

Remote IP	Virtual Remote IP	Virtual Local IP	Virtual Local Subnet Mask	Route	Route Subnet Mask	Key	Comment	Select	Edit

The description of the column is as below:

TERMS	DESCRIPTION
GRE	Check the box to enable the function.
Remote IP Address	Set the remote real IP Address of the GRE Tunnel
Virtual Remote IP Address	Set the remote virtual IP Address of the GRE tunnel.
Virtual Local IP Address	Set the local virtual IP Address of the GRE tunnel.
Virtual Local Subnet Mask	Set the remote virtual Netmask of the GRE tunnel.
Tunnel Route	Route, the default value is 0.0.0.0
Tunnel Route Subnet Mask	Set the subnet mask for the route
Key	Enter the key for the GRE tunnel.
Comment	Enter any comment to describe the configuration.
Select	Select the list on the table, so user can press Edit or Delete Selected to delete.

Click the **Refresh** button to refresh the list.

3.9 ROUTING

Layer 3 routing feature is requested since the hosts located in different broadcast domain can't communicate each other. The WoMaster Industrial Router is supported with two routing methods: static routing and dynamic routing. Dynamic routing makes use of RIPv2. The user can choose one routing method or combine the two methods to establish the routing table. In this Routing pages allows users create the Static Route and RIPv2 to do the routing.

3.9.1 STATIC ROUTE

A static route is a route that is created manually by a network administrator. Static routes are typically used in smaller networks. In static routing, the Router's routing table entries are populated manually by a network administrator. The opposite of a static route is a dynamic route. In dynamic routing, the routing table entries are populated with the help of routing protocols.

The major advantages of static routing are reduced routing protocol router overhead and reduced routing protocol network traffic. The major disadvantages of static routing are network changes require manual reconfiguration in routers and network outages cannot be automatically routed around. Also it is difficult to configure static routing in a complex network. Below is the Static Route section interface.

Static Route

Static Route

Destination:

Netmask:

Gateway:

Metric:

Interface:

Destination	Netmask	Gateway	Metric	Interface	Select	Edit
192.0.2.0	255.255.255.0	*	0	WAN	<input type="checkbox"/>	<input type="button" value="Edit"/>

The description of the column is as below:

TERMS	DESCRIPTION
Destination	The Destination network IP address. For example,192.168.10.0
Netmask	Destination network's subnet mask.
Gateway	Gateway. Factory default is blank (0.0.0.0).
Metric	Assigns a cost to each available route so that the most cost-effective path can be.
Interface	The outgoing network interface. LAN, WAN, and Cellular are available to setup here. The WAN interface will available in Router Mode.
Select	Select the list on the table, so user can press Edit or Delete Selected to delete.

Click the **Refresh** button to refresh the list.

3.9.2 RIPv2

WoMaster Industrial Router is supported with RIPv2. The Routing Information Protocol (RIP) is a distance-vector, interior gateway (IGP) routing protocol used by routers to exchange routing information. RIP uses the hop count as a routing metric. RIP prevents routing loops by implementing a limit on the number of hops allowed in a path from the source to a destination. The maximum number of hops allowed for RIP is 15. This hop limit, however, also limits the size of networks that RIP can support. RIP version 2 (RIPv2) was developed due to the deficiencies of the original RIP.

3.10 WARNING

WoMaster' router provides several types of Warning feature for remote monitoring of end devices status or network changes.

3.10.1 EMAIL ALERT

WoMaster router supports E-mail Warning feature. With this function being enabled, the user is allowed to configure the detail settings for sending the e-mail alert to the SMTP server when the events occur. This page allows User to enable E-mail Alert, assign the SMTP Server IP, Sender E-mail, and Receiver E-mail. If the SMTP server requests User to authorize first, User can also setup the username and password on this page.

Email Alert | Ping Watchdog | Syslog Setting | Relay Output | Event Type | SNMP ▾

Email Alert

Email Alert Enable

SMTP Server IP:

Email Account:

Authentication :

User Name:

Password:

Confirm Password:

Email 1 To :

Email 2 To :

The description of the columns is as below:

TERMS	DESCRIPTION
Email Alert	Check the to enable the function
SMTP Server IP Address	Enter the IP address of the Email Server
Email Account	Enter the Email Server Account

Authentication	Choose the Authentication mode (None, Plain, Login)
User Name	Enter email Account name (Max.40 characters)
Password	Enter the password of the email account
Confirm Password	Re-type the password of the email account
User can set up to 2 email addresses to receive email alarm from the router	
Email 1 To	The first email address to receive an email alert from the router (Max. 40 characters)
Email 2 To	The second email address to receive an email alert from the router (Max. 40 characters)

Once User finishes configuring the settings, click on **Submit** to apply the User configuration.

3.10.2 PING WATCHDOG

Email Alert
Ping Watchdog
Syslog Setting
Relay Output
Event Type
SNMP ▾

Ping Watchdog

Enable Ping IP Address 1

0.0.0.0

Enable Ping IP Address 2

0.0.0.0

Ping Interval

300

seconds

Watchdog Deferred

120

seconds(>120)

Ping Fail Counter

30

Submit
Cancel

Ping Watchdog is a feature that helps WoMaster' router to allow user continuously ping a specific remote host for connection status using a user-defined IP address (or an Internet gateway). In this section, WoMaster provides two target IP Addresses, in order if the other IP Address cannot be reached, so there is another backup IP address. There are two conditions in this Ping Watchdog section, the first one is when the device continuously ping the target IP and in the end, it can reach one of the target IPs the device would not reboot. But if both targets IPs cannot be reached, the device will start counting the Ping Fail Counter time till it can be reached. If it is unable to ping the target IP address, this device will automatically reboot. After User finishes configuring the settings, click on **Submit** to apply User configuration.

The description of the columns is as below:

TERMS	DESCRIPTION
Enable Ping IP Address 1	Clicks enable to activate the feature. Set the first IP Address to check if the device is alive or not
Enable Ping IP Address 2	Clicks enable to activate the feature. Set the second IP Address to check if the device is alive or not
Ping Interval	Default: 300 (seconds) Set the interval timer to Ping the remote device. Every 300 seconds the device will try to ping the target IP.

Watchdog Deferred	Default: 120 (seconds) >120 The device needs time to boot, the startup delay use to buffer to prevent the device continue to reboot itself.
Ping Fail Counter	Default: 30 When the remaining Ping Fail Counter reach to 0 or reach the failure count, the device will reboot.

Click **Submit** to apply the configuration.

3.10.3 SYSLOG SETTING

System Log is useful to provide system administrator locally or remotely monitor router events history.

Email Alert
Ping Watchdog
Syslog Setting
Relay Output
Event Type
SNMP ▾

System Log

Enable Remote Syslog Server

IP Address:

Port:

Submit
Cancel

Once User finishes configuring the settings, click on **Submit** to apply User configuration. User can monitor the system logs in [Diagnostics] / [Event Log] page

The condition or term described as following table.

TERMS	DESCRIPTION
Enable Remote Syslog Server	Select Enable to enable system log
IP Address	Specify the IP address of the server.
Port	Default: 514 Specify the port number of the server

After finish with the configuration, clicks **Submit** to activate the function.

3.10.4 RELAY OUTPUT

WoMaster' router provides 1 alarm relay output, also known as Digital Output. These settings in Relay Output section control the events that will trigger the alarm output. The Relay Output configuration interface has shown as below:

The screenshot shows the 'Relay Output' configuration page. At the top, 'Relay1' is set to 'OFF'. Below it, 'Link Failure' is configured to monitor ports 1 through 9, with checkboxes for each port. At the bottom, there are three buttons: 'Submit', 'Cancel', and 'Reload'.

The condition or term described as following table.

TERMS	CONDITION	DESCRIPTION
Relay	ON or OFF	The status change to ON if any kind of failure is detected. OFF if the status is normal.
Link Failure	LAN Port number 1 - 9	Monitoring port link down event

After finishing the configuration, clicks **Submit** to activate the relay alarm function.

3.10.5 EVENT TYPE

In this page user allowed to select the Event Type **Event Warning Type**: The event warning type selection. It has two event types, Authentication Failure and Configuration Changed.

The screenshot shows the 'Event Type' configuration page. At the top, there are tabs for 'Email Alert', 'Ping Watchdog', 'Syslog Setting', 'Relay Output', 'Event Type', and 'SNMP'. The 'Event Type' tab is active. Below it, 'Event Type' is set to 'Enable'. There are two rows: 'Authentication Failure' with a checked 'Enable' checkbox, and 'Configuration Changed' with a checked 'Enable' checkbox. At the bottom, there are 'Submit' and 'Cancel' buttons.

TERMS	DESCRIPTION
Authentication Failure	When the authentication fails, the system will issue the event log/email alert to the system log/SMTP server respectively.
Configuration Changed	When there are any kinds of changing in the configuration, the system will issue the event log/email alert to the system log/SMTP server respectively.

Click **Submit** to apply the configuration.

3.10.6 SNMP

SNMP is a standard TCP/IP protocol for network management. Network administrators use SNMP to monitor and map network availability, performance, and error rates. System management software uses SNMP to allow administrators to remotely monitor and manage thousands of systems on a network, often by presenting the data gathered from monitored devices in a snapshot or dashboard view. WoMaster' Router support SNMP V2c and V3

The screenshot shows a web interface for configuring SNMP settings. The navigation bar includes tabs for 'Email Alert', 'Ping Watchdog', 'Syslog Setting', 'Relay Output', 'Event Type', and 'SNMP'. The 'SNMP Settings' section is active, displaying the following configuration options:

- Enable SNMP:** Enable
- Protocol Version:** V2c (dropdown menu)
- Server Port:** 161 (text input)
- Get Community:** public (text input)
- Set Community:** private (text input)

The **SNMP Trap Server** section includes:

- SNMP Trap:** Enable
- Trap Server:** 0.0.0.0 (text input)
- Trap Community:** public (text input)

At the bottom of the form are two buttons: 'Submit' and 'Cancel'.

SNMP Setting

In this page, user may configure the SNMP setting, click enable to activate the function. Select the Protocol version (V2c/V3), configure the server port, set up the password for the Get Community and specify the password for Set Community.

SNMPv2C

SNMPv2c is a sub-version of SNMPv2. Its key advantage over previous versions is the Inform command. Unlike Traps, which are simply received by a manager, Informs are positively acknowledged with a response message. If a manager does not reply to an Inform, the SNMP agent will resend the Inform.

SNMP V3

SNMPv3 is the newest version of SNMP. Its primary feature is enhanced security.

SNMPv3 security comes primarily in 2 forms:

- **Authentication** is used to ensure that traps are read by only the intended recipient.
- **Privacy** encrypts the payload of the SNMP message to ensure that it cannot be read by unauthorized users.

The description of the columns is as below:

TERMS	DESCRIPTION
Enable SNMP	Click the box to enable the SNMP function.
Protocol Version	<p>Default: V2c Select the SNMP protocol version.</p> 
Server Port	<p>Default: 161 Sets the port on which SNMP data has been sent. User can specify port by marking on user defined and specify port that user wants SNMP data to be sent.</p>
Get Community	<p>Default: public Create the name for a group or community of administrators who can view SNMP data.</p>
Set Community	<p>Default: private Create the name for a group or community of administrators who can write or edit SNMP data.</p>

After finishing the configuration, clicks **Submit** to activate the function.

SNMP Trap Server

SNMP trap is the most frequently used SNMP messages. These messages are sent to the manager by an agent when an issue needs to be reported. SNMP traps are quite unique if compared to other message types, since they are the only method that can be directly initiated by an SNMP agent. The other types of messages are either initiated by the SNMP manager or sent as a result of the manager's request. This ability makes SNMP traps indispensable in most networks. It is the most convenient way for an SNMP agent to inform the manager that something wrong is going on.

The description of the columns is as below:

TERMS	DESCRIPTION
SNMP Trap	Clicks enable to activate the function. All of events that associated with the device will be sent to the server in real time, and can be seen by remote clients
Trap Server	<p>Default: 0.0.0.0 Set the IP Address of the trap server where to report the events.</p>
Trap Community	<p>Default: public Create the name for a group or community of administrators who can allow reporting the events. If the group is match then the events can be reported.</p>

After finish with the configuration, clicks **Submit** to activate the function.

SNMP V3

SNMP v3 can provide more security functions when the user performs remote management through SNMP protocol. This field displays the SNMPv3 configuration page for Admin and User. If the value from Access Type is set to **Read-Write**, the SNMPv3 user will be able to set and retrieve parameters on the system. And if the value is set to **Read Only**, the SNMPv3 user will only be able to retrieve parameter information. It delivers SNMP information to the administrator with user authentication; all of data between the router and the administrator are encrypted to ensure secure communication. SNMPv3 requires an authentication level of MD5 or DES to encrypt data to enhance data security. To activate the page make sure user has already chosen SNMPv3 at the SNMP Setting page.

Email Alert	Ping Watchdog	Syslog Setting	Relay Output	Event Type	SNMP ▾
SNMP V3					
SNMPv3 Admin		<input checked="" type="checkbox"/> Enable			
Admin User Name:	<input type="text" value="SNMPv3Admin"/>				
Admin Password:	<input type="password"/>				
Confirm Password:	<input type="password"/>				
Access Type:	Read/Write ▾				
Authentication Protocol:	MD5 ▾				
Privacy Protocol:	None ▾				
SNMPv3 User		<input checked="" type="checkbox"/> Enable			
User Name:	<input type="text" value="SNMPv3User"/>				
Password:	<input type="password"/>				
Confirm Password:	<input type="password"/>				
Access Type:	Read Only ▾				
Authentication Protocol:	MD5 ▾				
Privacy Protocol :	None ▾				

TERMS	DESCRIPTION
SNMPv3 Admin	Clicks enable to activate the function and the entries for SNMPv3 Admin.
Admin User Name	Default: SNMPv3Admin Set up the User Name for the SNMPv3 Admin
Admin Password	Set up the Password for the SNMPv3 Admin
Confirm Password	Confirm the Admin for the SNMPv3 Admin
Access Type	Access type for the SNMPv3 Admin, choose Read Only or Read and Write
Authentication Protocol	Default: MD5 Provides authentication based on MD5 or SHA algorithms.
Privacy Protocol	Specify the encryption method for SNMP communication. None and DES are available.

	<p>None: No encryption is applied.</p> <p>DES: Data Encryption Standard, it applies a 58-bit key to each 64-bit block of data.</p>
SNMPv3 User	Clicks enable to activate the function and the entries for SNMPv3 User
User Name	<p>Default: SNMPv3User</p> <p>Set up the User Name for the SNMPv3 User</p>
Password	Set up the Password for the SNMPv3 User
Confirm Password	Confirm the Admin for the SNMPv3 User
Access Type	Access type for the SNMPv3 User, choose Read Only or Read and Write
Authentication Protocol	<p>Default: MD5</p> <p>Provides authentication based on MD5 or SHA algorithms.</p>
Privacy Protocol	<p>Specify the encryption method for SNMP communication. None and DES are available.</p> <p>None: No encryption is applied.</p> <p>DES: Data Encryption Standard, it applies a 58-bit key to each 64-bit block of data.</p>

3.11 DIAGNOSTICS

WoMaster Router provides several types of features for User to monitor the status of the router or diagnostic for User to check the problem when encountering problems related to the router.

Following commands are included in this group:

3.11.1 Event Logs

3.11.2 ARP Table

3.11.3 Port Statistic

3.11.4 Ping

3.11.5 Traceroute

3.11.6 Association List

3.11.1 EVENT LOGS

When remote System Log server mode is activated, the router will record occurred events in local log table. This page shows this log table. The entry includes the index, occurred data, time and content of the events.

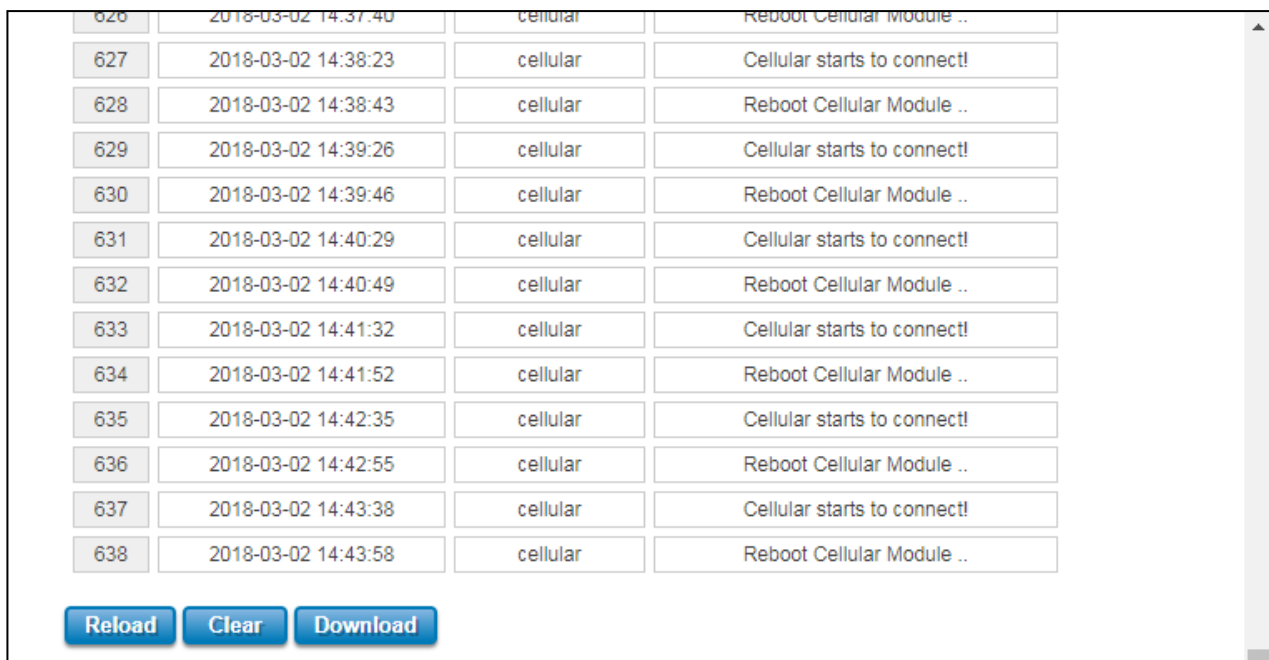

The screenshot displays a table of event logs with the following columns: Index, Time, Source, and Message. Below the table are three buttons: Reload, Clear, and Download.

Index	Time	Source	Message
626	2018-03-02 14:37:40	cellular	Reboot Cellular Module ..
627	2018-03-02 14:38:23	cellular	Cellular starts to connect!
628	2018-03-02 14:38:43	cellular	Reboot Cellular Module ..
629	2018-03-02 14:39:26	cellular	Cellular starts to connect!
630	2018-03-02 14:39:46	cellular	Reboot Cellular Module ..
631	2018-03-02 14:40:29	cellular	Cellular starts to connect!
632	2018-03-02 14:40:49	cellular	Reboot Cellular Module ..
633	2018-03-02 14:41:32	cellular	Cellular starts to connect!
634	2018-03-02 14:41:52	cellular	Reboot Cellular Module ..
635	2018-03-02 14:42:35	cellular	Cellular starts to connect!
636	2018-03-02 14:42:55	cellular	Reboot Cellular Module ..
637	2018-03-02 14:43:38	cellular	Cellular starts to connect!
638	2018-03-02 14:43:58	cellular	Reboot Cellular Module ..

Buttons: Reload, Clear, Download

TERMS	DESCRIPTION
#	Event index assigned to identify the event sequence.
Time	The time is updated based on how the current date and time is set in the Basic Setting page.
Source	Show the log's source.
Message	Show the record status.

Click **Reload** to refresh the table. Click **Clear** to remove the entire event logs list. User may download the event logs file by click **Download**.

3.11.2 ARP TABLE

Basically, WoMaster device is supported with two types of ARP which is the standard ARP and ARP with 802.2 LLC Type 2. Address Resolution Protocol (ARP) is a protocol for mapping an Internet Protocol address (IP address) to a physical machine address that is recognized in the local network. A table, usually called the ARP cache, is used to maintain a correlation between each MAC address and its corresponding IP address. ARP provides the protocol rules for making this correlation and providing address conversion in both directions. The other ARP feature is ARP with 802.2 LLC Type 2 is the new level of ARP where the device will response the request of 802.2 snap ARP on the Ethernet port and not support sending the request of 802.2 snap ARP. Below is the Data format.

Data Format

Protocol Header:

802.3 + 802.2 LLC + 802.2 snap

| - (DS + SA + Len) - | - DSAP + SSAP + CTRL - | - Org + type

This page shows the routers active ARP table. An ARP table contains recently cached MAC addresses of every immediate device that was communicating with the router.

Event Logs	ARP Table	Ping	Network Statistics
ARP Table			
IP Address	MAC Address	Interface	
192.168.10.80	70:8b:cd:03:b5:67	br0	
Reload			

Click on **Reload** to change the value.

3.11.3 PORT STATISTICS

In this page, User can view operation statistics for each port. The statistics that can be viewed include Link, Rx Good, Rx Bad, Rx Abort, Tx Good, Tx Bad and Collision. Rx means the received packet while Tx means the transmitted packets.

Port Statistics

Port	Link	Rx Good	Rx Bad	Rx Abort	Tx Good	Tx Bad	Collision
<input type="checkbox"/> 1	Up	960	77	0	1194	0	0
<input type="checkbox"/> 2	Down	0	0	0	0	0	0
<input type="checkbox"/> 3	Down	0	0	0	0	0	0
<input type="checkbox"/> 4	Down	0	0	0	0	0	0
<input type="checkbox"/> 5	Down	0	0	0	0	0	0
<input type="checkbox"/> 6	Down	0	0	0	0	0	0
<input type="checkbox"/> 7	Up	25205	9226	0	14354	0	0
<input type="checkbox"/> 8	Down	0	0	0	0	0	0

If the table shows many Bad, Abort or Collision counts increased, that may mean network cable is not connected well, the network performance of the port is poor, etc. Please check network cable, Network Interface Card of the connected device, the network application, or reallocate the network traffic, etc.

Click on **Clear Selected** to reinitialize the counts of the selected ports, and **Clear All** to reinitialize the counts of all ports. Click on **Reload** to refresh the counts.

3.11.4 PING

WoMaster' provides **Ping** utility in the management interface, the function is to give users a simple but powerful tool for troubleshooting network problems and check that the remote device is still alive or not. Type **Destination IP** address of the target device and click on **Ping** to start the ping.

Ping

Destination

Ping

```
PING 192.168.10.80 (192.168.10.80): 56 data bytes
64 bytes from 192.168.10.80: icmp_seq=0 ttl=128 time=0.2 ms
64 bytes from 192.168.10.80: icmp_seq=1 ttl=128 time=0.3 ms
64 bytes from 192.168.10.80: icmp_seq=2 ttl=128 time=0.3 ms
64 bytes from 192.168.10.80: icmp_seq=3 ttl=128 time=0.2 ms

--- 192.168.10.80 ping statistics ---
4 packets transmitted, 4 packets received, 0% packet loss
round-trip min/avg/max = 0.2/0.2/0.3 ms
```

3.11.5 TRACEROUTE

Traceroute is a diagnostics tool for displaying the route (path) and measuring transit delays of packets across an Internet IP network. Log containing route information will be shown after few seconds. Enter the destination IP Address then click traceroute to start the process.

Trace Route

Destination

Traceroute

It will start search the route and measuring the transit delays of the packet.

Trace route for 192.168.10.70

```
1 192.168.10.70 (192.168.10.70) 0.399 ms 0.37 ms 0.366 ms
```

OK

3.11.6 ASSOCIATION LIST

This Association List displays the current wireless connection status when there is a client that connected to the AP. It shows the SSID, MAC Address, Signal Strength, Noise Floor, Connection Time, Last IP and Action. For the security concern, in this page user can do the security action, such as **Kick** the unexpected user from the wireless networks. This page also provides the refresh function to refresh the list automatically, where user may set the refresh period for refresh the list. Click **Set** to apply the setting, click **Stop** to stop the refresh function.

Association List

Refresh Period (0-65534) sec

SSID	MAC Address	Signal Strength	Noise Floor	Connection Time	Last IP	Action
WR322_1	78:02:f8:3f:ad:53	-50	-96	2018-1-3_18:13:23	192.168.10.100	Kick

Click **Reload** to refresh the list.

The description of the columns is as below:

TERMS	DESCRIPTION
SSID	Display the primary name of the SSID that available on the network.
MAC Address	Display the MAC Address that connected to the AP.
Signal Strength	Display the connection signal strength.
Noise Floor	Display the background noise level.
Connection Time	Display the time when the client connected to the AP.
Last IP	Show the IP Address of the wireless client.
Action	In this section user may do an action by kick the unexpected wireless client.

3.12 IoT

Over the past decade or so, the word “cloud” has taken on a new meaning to many people. Rather than a visible mass of condensed water vapor floating in the sky, the cloud has taken to the IoT industry in the form of data. WoMaster Industrial Router is supported with private clouds, ThingsMaster and public clouds, AWS and Microsoft Azure. Clouds offer great promise in improving the agility and flexibility of IT to respond to the requirements of the business cost effectively. The security challenges raised by the loss of control and visibility in the journey to the cloud can be addressed in terms of securing infrastructure, information, identities, and devices.

3.12.1 AWS IoT

Amazon Web Services IoT enables secure, bi-directional communication between Internet-connected things (such as sensors, actuators, embedded devices, or smart appliances) and the AWS cloud over MQTT and HTTP. For more information please visit: <http://aws.amazon.com/iot/>.

AWS IoT

Enable	<input checked="" type="checkbox"/>		
AWS Root CA	Load		<input type="button" value="Delete"/>
AWS Certificate file	Load		<input type="button" value="Delete"/>
AWS Private Key file	Load		<input type="button" value="Delete"/>
Target Host	<input type="text" value="a279rf4cdqyuy8.iot.us-west-2.amazonaws.com"/>		
Port	<input type="text" value="443"/>		
Client ID	<input type="text" value="WR322"/>		
My Thing Name	<input type="text" value="WR322"/>		

The description of the columns is as below:

TERMS	DESCRIPTION
Enable	Enable the AWS IoT function
AWS Root CA	Root CA is necessary. User can download it from the AWS.
AWS Certificate file	Certificate is necessary. User can download it from the AWS.
AWS Private Key file	Private key is necessary. User can download it from the AWS.
Target Host	Enter the target host
Port	Default: 433 Because AWS uses the HTTPS traffic, user need to add an inbound rule on port 443
Client ID	Enter the device client ID
My Thing Name	Enter the registered device name (Need to be the same)

Click **Submit** to apply the configuration.

HOW TO CONNECT THE DEVICE TO AWS

- Create and login to AWS account.
- Select AWS IoT Services – click Thing.
- Add your device shadow.

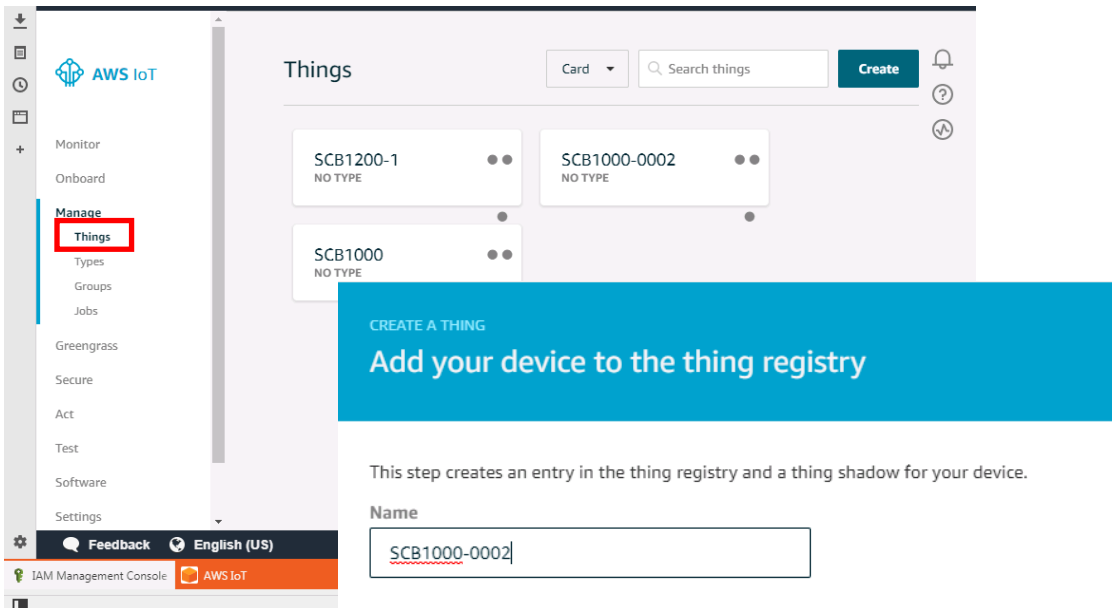

- Create and download the key or certificate.

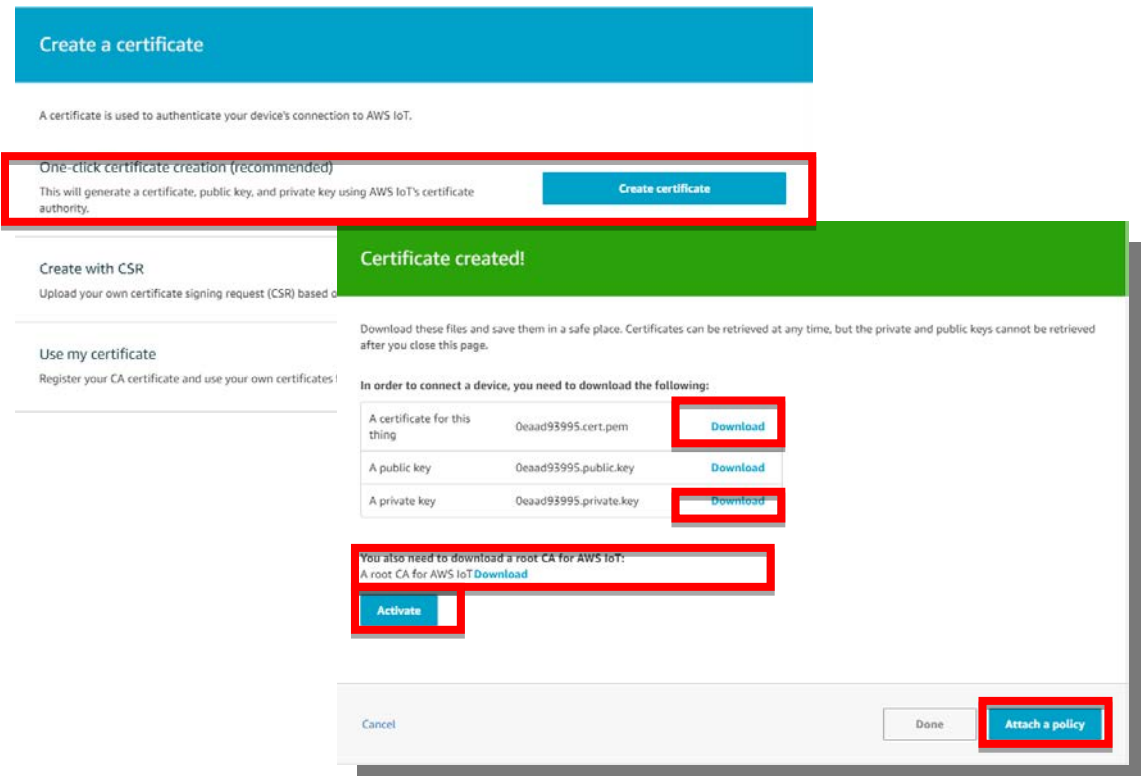

Certificate, private key, root CA is necessary. Public key is used by AWS server to authenticate with private key. The public key and private cannot be downloaded back after the user closes the page. Policy can be added later.

- Get the Target host to connect with the device.
Go to Manage -> Things -> click the device name -> Click Interact.
Copy the HTTPS link to update user's Thing Shadow using this Rest API Endpoint.

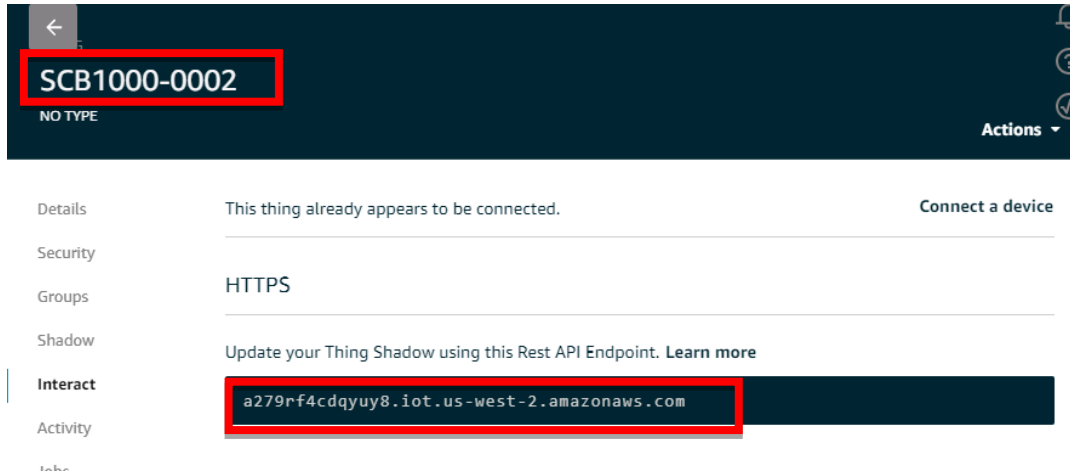

- Connect the device to AWS.
Copy the link and paste on the Target Host field at the AWS IoT page.

The screenshot shows the 'AWS IoT' configuration page. The 'Enable' checkbox is checked. The 'Target Host' field is populated with 'a279rf4cdqyuy8.iot.us-west-2.amazonaws.com'. The 'Port' field is set to '443'. The 'Client ID' and 'My Thing Name' fields are both set to 'SCB1000-0002'. There are three 'Delete' buttons for 'AWS Root CA', 'AWS Certificate file', and 'AWS Private Key file'. At the bottom, there are 'Submit' and 'Cancel' buttons.

3.12.2 AZURE IoT

Azure IoT Hub is a fully managed service that enables reliable and secure bi-directional communications between millions of Internet of Things (IoT) devices and a solution back end. One of the biggest challenges that IoT projects face is how to reliably and securely connect devices to the solution back end. To address this challenge, IoT Hub:

- Offers reliable device-to-cloud and cloud-to-device hyper-scale messaging.
- Enables secure communications using per-device security credentials and access control.
- Includes the most popular communication protocols.

Azure IoT

Enable

Root CA Load Delete

IoT Hub

Port

Client ID

SAS Token

Submit
Cancel

The description of the columns is as below:

TERMS	DESCRIPTION
Enable	Enable Azure IoT function
Root CA	Download and enter the root CA.
IoT Hub	Enter the IoT hub server, this information can be found at the azure platform
Port	Default: 8883 Display the port number. Because Azure IoT uses the MQTT protocol, so user needs to enter 8883 port number that belongs to MQTT protocol.
Client ID	Enter the client ID
SAS Token	Enter the SAS Token that needs to be generated by software. (Azure Device Explorer)

Click **Submit** to apply the configuration.

HOW TO CONNECT THE DEVICE TO MICROSOFT AZURE

CREATE IOT HUB

To register the device in Azure Portal, user has to follow the guide “Get started with Azure IoT Hub for Java”: <https://azure.microsoft.com/en-us/documentation/articles/iot-hub-java-java-getstarted/>.

The guide explains how to create an IoT Hub and a device entity. It is important to annotate the connection string generated after creating the device entity. User will need this parameter later for the device configuration (WoM IoT Configuration).

CONFIGURE THE DEVICE AS A MQTT CLIENT

In the Microsoft Azure Portal, go to IoT Hub menu and select:

Devices > myCreatedDevice > Shared access policies > iothubowner > Connection string - primary key.

User has to annotate the value of this field.

1. Get the connection string. Click the IoT Hub -> Shared access policies.

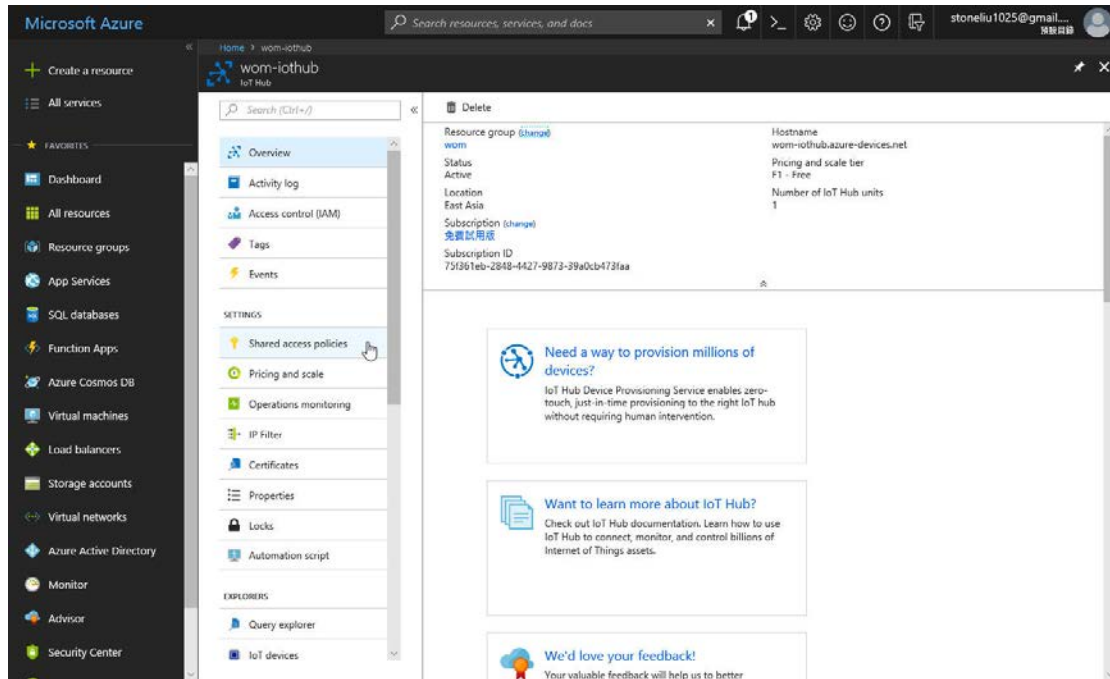

2. Click registryReadWrite -> copy the Connection string---Primary Key.

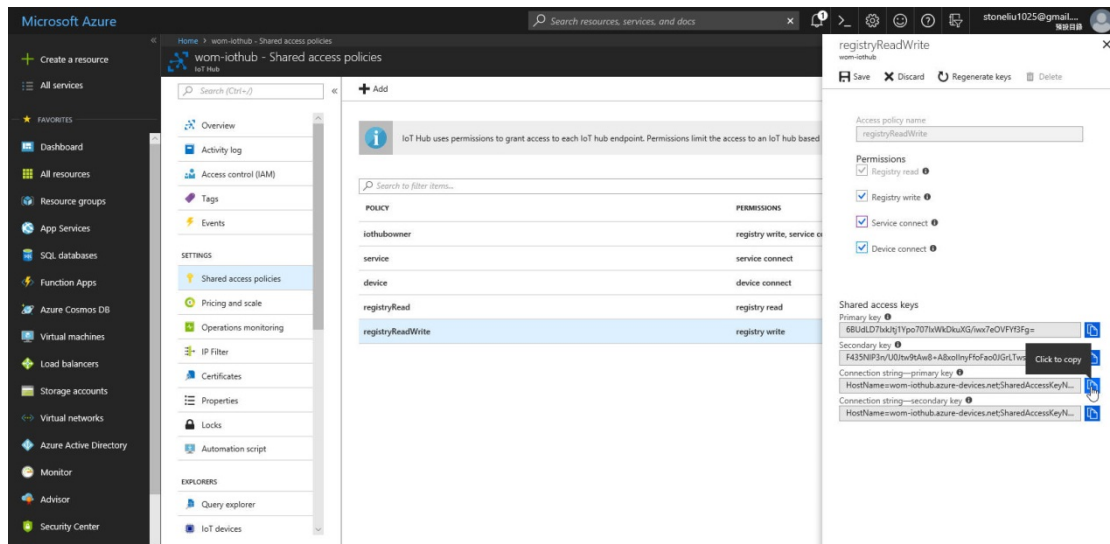

3. Download and install the Azure Device Explorer to generate the SAS Token. Go to this link to download the software: <https://github.com/Azure/azure-iot-sdk-csharp/releases/download/2018-3-13/SetupDeviceExplorer.msi>

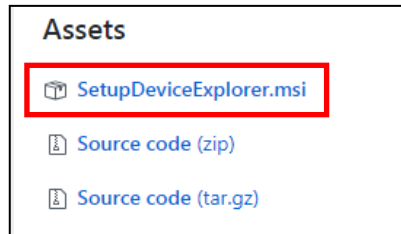

4. Paste the Connection String --- Primary Key to the IoT Hub Connection String box. Then type the Protocol Gateway HostName and click Update. In the end, generate the SAS Token.

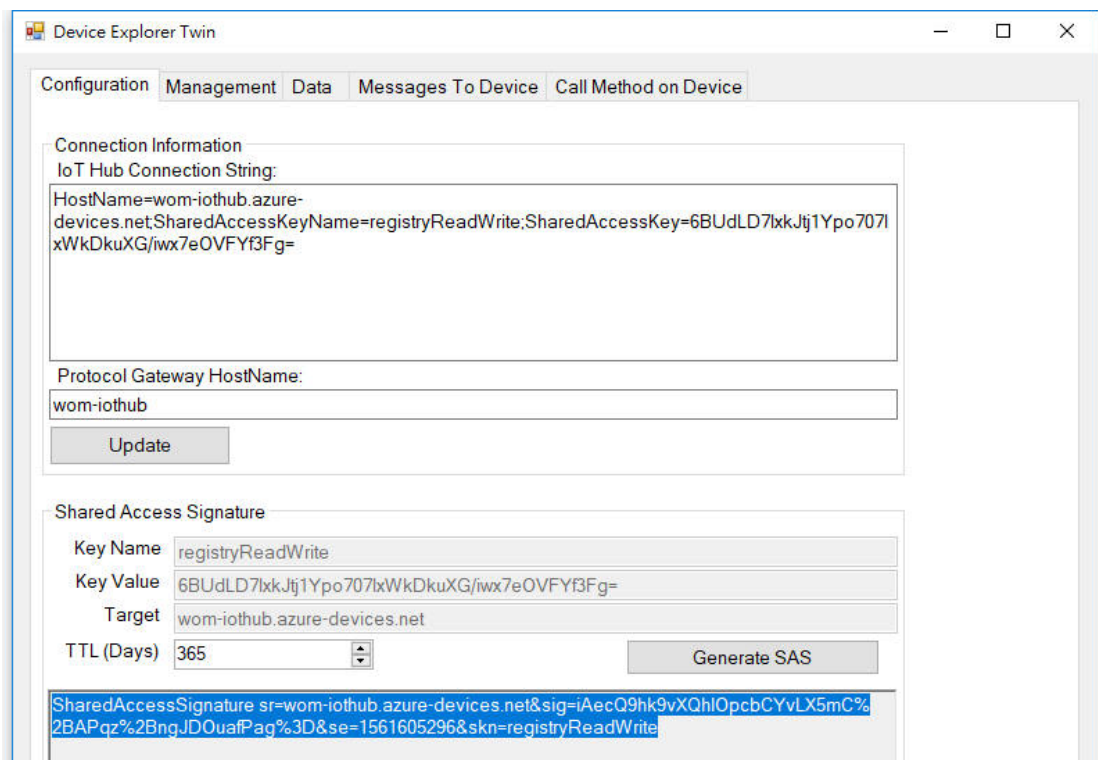

5. Configure the MQTT Client from the Web GUI. Enter the value based on the IoT Hub setting. And the device is connected to the cloud.

Please find the Root CA through this link: <https://github.com/Azure/azure-iot-sdk-c/blob/master/certs/certs.c>

3.12.3 PRIVATE IoT

WoMaster provides its private cloud service, ThingsMaster that could support the Industrial Plants Network. Under the cloud architecture, software, hardware, applications, and storage can all be provided as services. The cloud network service has the advantages of easy expansion, rapid adjustment, and minimal management, and can dynamically meet increasing demands. Users can access the data which stored on the cloud anywhere, anytime, and seamlessly share to any authorized users.

The description of the columns is as below:

TERMS	DESCRIPTION
Enable	Enable the WoM IoT function
IoT Server	Enter the specific IoT Server.
Client ID	Enter the client ID that has been registered.
MQTT Publish Topic	Specify the MQTT Topic
CA Certificate	The function from this certificate file is to create an encrypted MQTT communication. User will get this file when download the ThingsMaster server file. Note. This field only supports in ThingsMaster v1.1

Click **Submit** to apply the configuration.

HOW TO ESTABLISH AND CONNECT TO THE THINGSMASTER CLOUD SERVER

1. Download and install VMware Workstation Player.

Please click the link below.

https://my.vmware.com/en/web/vmware/free#desktop_end_user_computing/vmware_workstation_player/14_0

2. Download the server file from the link that sent by the Sales.

3. Open a Virtual Machine from disk and import.

Note: Ignore the warning message, check “Do not show this message again” then click Retry.

4. Configure network adapter of ThingsMaster VM to make sure that the laptop or the computer can ping the Virtual Machine.

- Go to Player -> Managed -> Virtual Machine Settings
- Choose the Network Adapter
- Set the Network Connection to Bridged
- Click Configure Adapters
- Select the Network Card that user used, user may choose either Wireless or Ethernet connection.

Note: User should only enable the NIC which under the same network with the device.

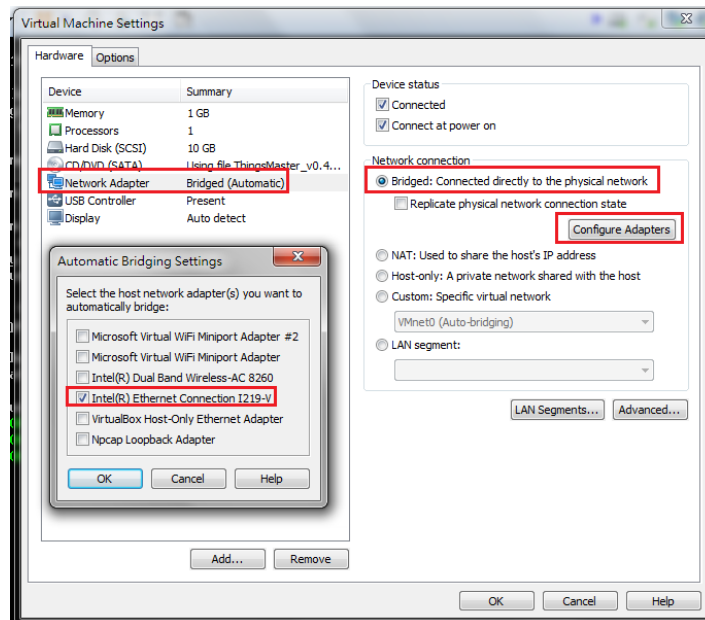

5. Start the Virtual Machine, wait till the starting process is done then the ThingsMaster is established.

```

ThingsMaster_V0.4 - VMware Workstation 14 Player (Non-commercial use only)
Player
System information as of Fri Aug 17 01:26:35 CST 2018
System load: 0.62      Memory usage: 9%      Processes: 196
Usage of /: 51.9% of 8.73GB  Swap usage: 0%      Users logged in: 0
Graph this data and manage this system at:
https://landscape.canonical.com/
179 packages can be updated.
126 updates are security updates.
user@ubuntu:~$ UIC media player 2.2.0 Weatheruax (revision 2.2.7-14-g3cc1d0ba9)
[0000000014c7340] core interface error: no suitable interface module
[000000001426118] core libvlc error: interface "globalhotkeys.none" initialization failed
[0000000014c7348] dummy interface: using the dummy interface module...
[00007f46fc0009b0] core input error: ES_OUT_SET_GROUP_PCR is called too late (pts_delay increased
to 300 ns)
[00007f46fc0009b0] core input error: ES_OUT_RESET_PCR called
[00007f46fc0009b0] core input error: ES_OUT_SET_GROUP_PCR is called too late (pts_delay increased
to 383 ns)
[00007f46fc0009b0] core input error: ES_OUT_RESET_PCR called
[00007f46fc0009b0] core input error: ES_OUT_SET_GROUP_PCR is called too late (pts_delay increased
to 509 ns)
[00007f46fc0009b0] core input error: ES_OUT_RESET_PCR called
[00007f46fc0009b0] core input error: ES_OUT_SET_GROUP_PCR is called too late (pts_delay increased
to 547 ns)
[00007f46fc0009b0] core input error: ES_OUT_RESET_PCR called
user@ubuntu:~$ [00007f46fc0009b0] core input error: ES_OUT_SET_GROUP_PCR is called too late (pts_
delay increased to 637 ns)
[00007f46fc0009b0] core input error: ES_OUT_RESET_PCR called
[00007f46fc0009b0] core input error: ES_OUT_SET_GROUP_PCR is called too late (pts_delay increased
to 719 ns)
[00007f46fc0009b0] core input error: ES_OUT_RESET_PCR called
user@ubuntu:~$ _

```

6. Open a web browser to Login to Webmin by SSL in order to change some VM configurations.

Default: <https://192.168.10.101:10000>

User Name/Password: user/user

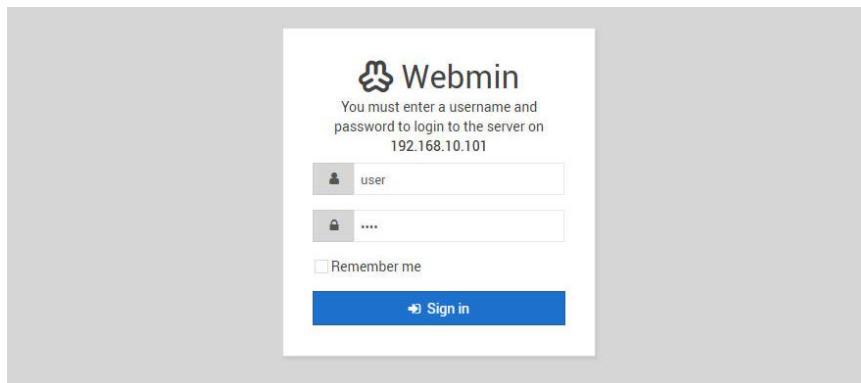

7. Configure the IP address and Gateway (optional). Select 'eth0' to change IP address and add default gateway if needed.

8. Configure Date & Time of the ThingsMaster Virtual Machine.

Please adjust the time and change time zone of the VM first. User can configure it from the Webmin interface. Go to Hardware -> System Time -> Set Time -> Change Time Zone

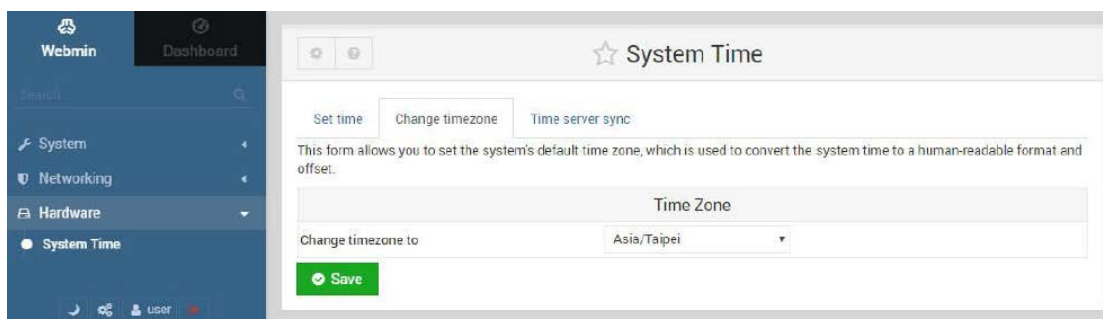

9. Adjust the time setting by using NTP

ThingsMaster server has already enabled NTP service; user can synchronize the system time of the device by using NTP.

- Enable the NTP Client from the Web GUI -> choose the Manual IP -> enter the server IP Address (192.168.10.101)

Date and Time

Current Time Yr Mon Day Hr Mn Sec

Time Zone

NTP Enable NTP client update

NTP server

Manual IP

10. Enable WoM IoT service and get connected to the ThingsMaster.

- System
- Ethernet Port
- PoE
- QoS
- Multicast
- Redundancy
- Serial
- GPS
- Security
- Warning
- Diagnostics
- IoT ▶
- Backup/Restore
- Firmware Upgrade
- Reset to Default

AWS IoT

Azure IoT

WoM IoT

Modbus Device

WoM IoT

Enable

IoT Server

Client ID

MQTT Publish Topic

3.12.4 RMS

This page allows the user to configure the Remote Management System for the device, so that the device will be monitored through the ThingsMaster RMS.

Remote Management System

Enable

RMS Server

Port

ACCESS TOKEN

GPS location User Input By Hardware

Latitude

Longitude

CA Certificate Load Delete

SubmitCancel

The description of the columns is as below:

TERMS	DESCRIPTION
Enable	Check the box to enable the RMS function.
RMS Server	Enter the RMS Server IP Address
Port	Default: 8883
ACCESS TOKEN	Generate the token from ThingsMaster RMS; this access token is used to access the device.
GPS Location	User Input: User input the device location information. By Hardware: if the device is supported with the GPS feature, then it will directly generate the location.
Latitude	Enter the Latitude coordinate of the device
Longitude	Enter the Longitude coordinate of the device
CA Certificate	The function from this certificate file is to create an encrypted MQTT communication. User will get this file when download the ThingsMaster server file. Note. This field only supports in ThingsMaster v1.1

Click Submit to apply the configuration. After succeed with the registration then the device will appear on the ThingsMaster RMS dashboard.

HOW TO ESTABLISH AND CONNECT TO THE THINGSMASTER RMS SERVER

1. Contact our Sales to get the access to the ThingsMaster RMS Account.
2. Login to ThingsMaster RMS, using RMS Account.

Login: <User RMS Account>

Password: <User RMS Password>

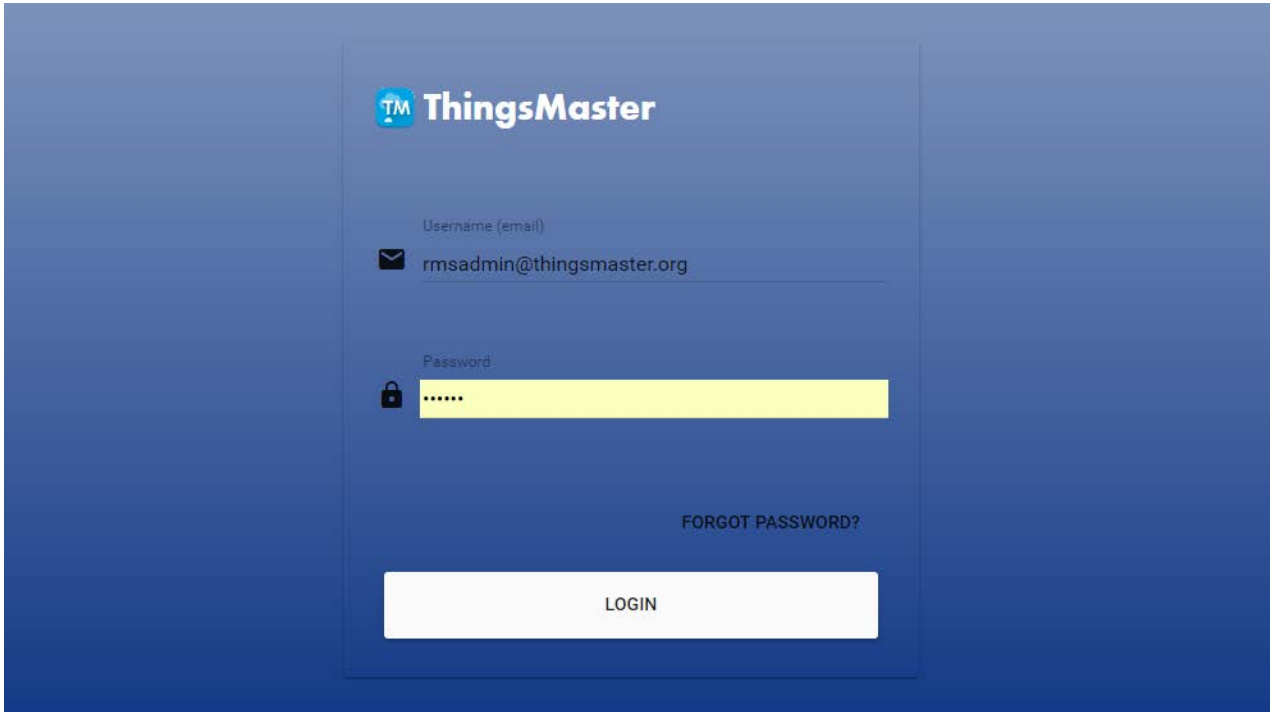

3. Go to Home -> Device Management to register the device.

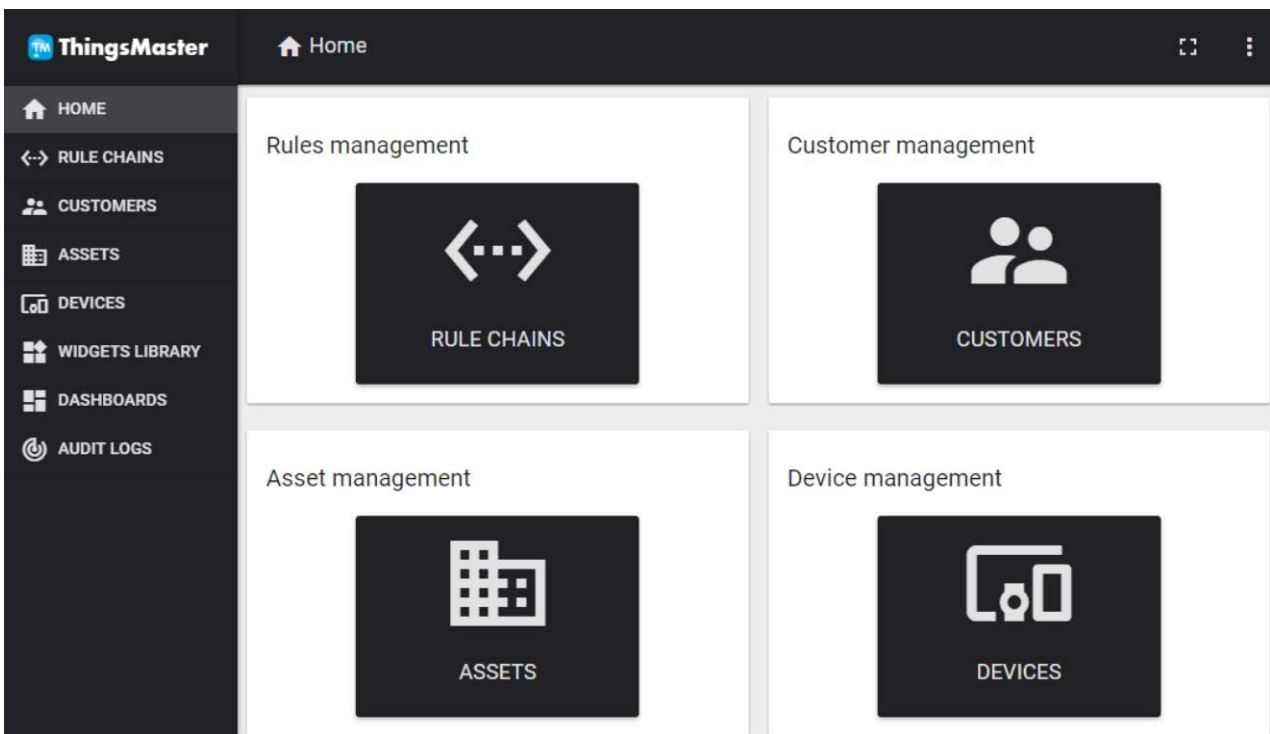

4. Add new device information, by clicking the “+” at the corner of the page.

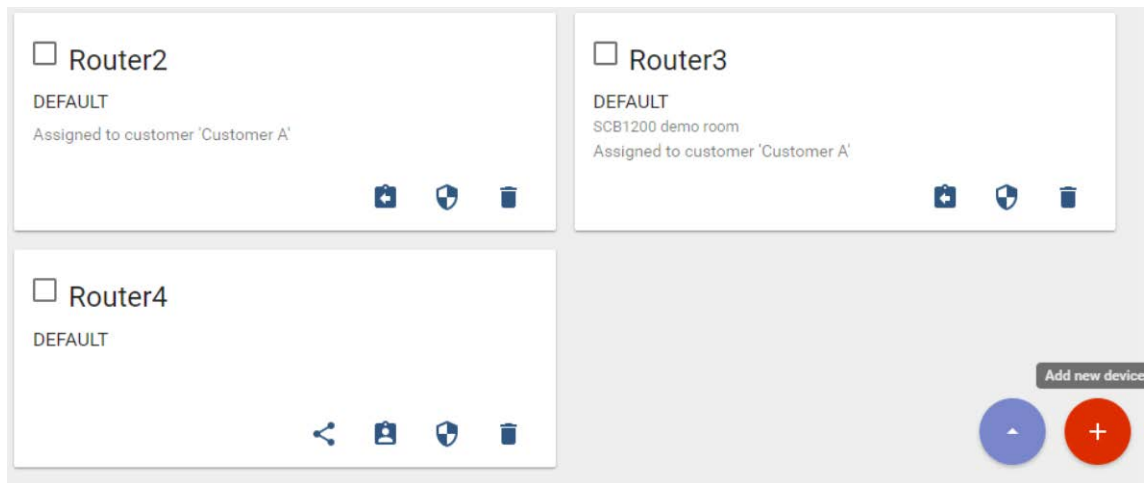

After click “+” menu then a page will pop up. Enter the device information.

- Name: Please start the name with Router + Number.
- Device type: default
- Is gateway: check the box
- Click **Add**

The 'Add Device' modal is shown with a dark header containing a question mark and a close icon. The form fields are: 'Name*' with the value 'Router5', 'Device type*' with the value 'default', 'Is gateway' with a checked checkbox, and 'Description' which is empty. At the bottom, there are two buttons: 'ADD' and 'CANCEL'.

5. After the device is registered, then click on the device folder go to Details -> Click on Copy Access Token. This access token is code to link the device with the RMS Server.

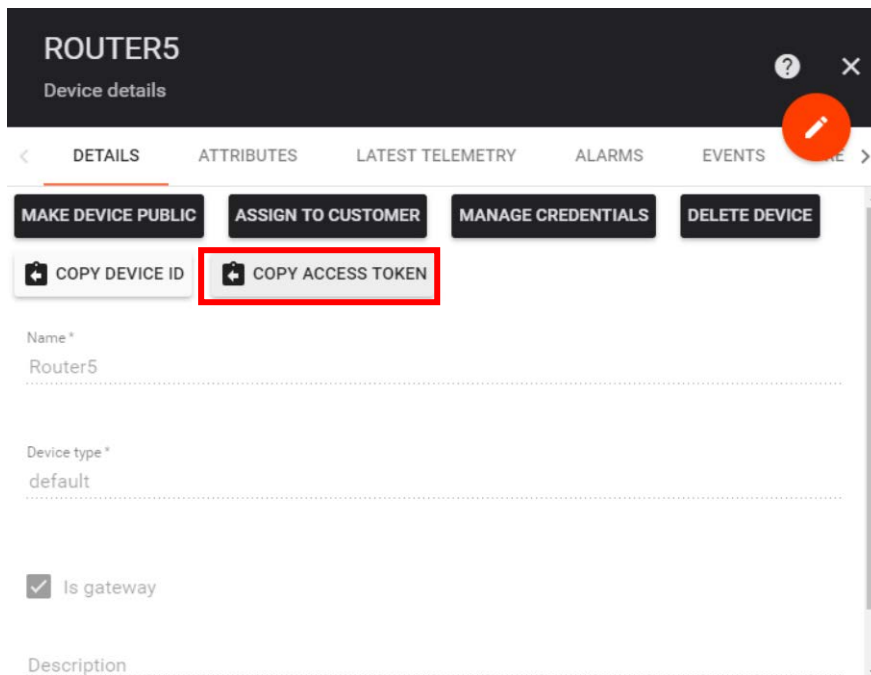

6. Go to the Web GUI -> IoT -> RMS. Paste the Access Token code to the Web GUI. And complete the configuration.

The screenshot shows the 'Remote Management System' configuration page. It has a title 'Remote Management System' at the top. Below the title are several configuration options: 'Enable' with a checked checkbox; 'RMS Server' with a text input field containing '54.202.64.3'; 'Port' with a text input field containing '8883'; 'ACCESS TOKEN' with a text input field containing 'MCR1lwolyCJnX5z5SoS1'; 'GPS location' with radio buttons for 'User Input' (selected) and 'By Hardware'; 'Latitude' with a text input field containing '53.2734'; 'Longitude' with a text input field containing '-7.77832031'; and 'CA Certificate' with a 'Load' button. At the bottom right is a 'Delete' button. At the bottom left are 'Submit' and 'Cancel' buttons.

7. After the configuration is done then go back to ThingsMaster RMS Server. And then click on the newly added Router -> Attributes-> Client Attributes to see if the data has been uploaded.

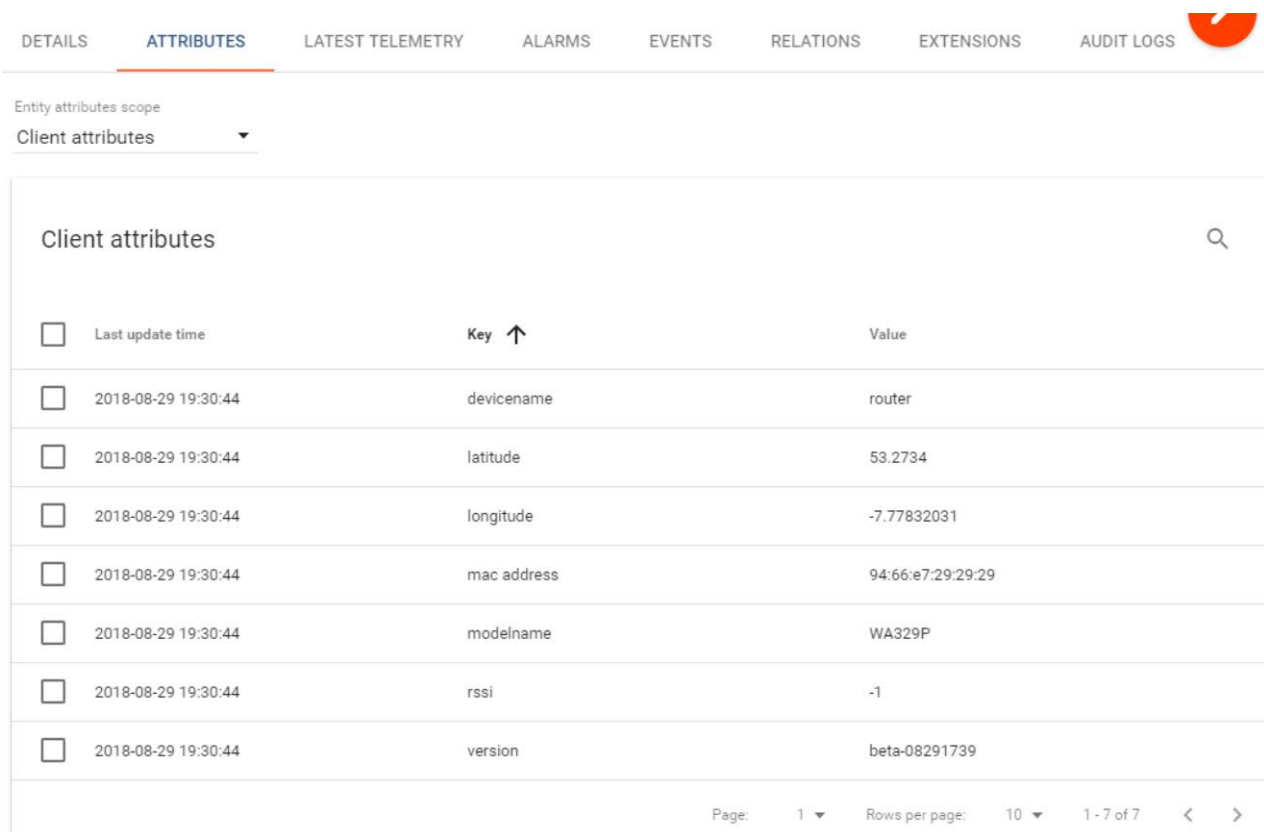

<input type="checkbox"/>	Last update time	Key ↑	Value
<input type="checkbox"/>	2018-08-29 19:30:44	devicename	router
<input type="checkbox"/>	2018-08-29 19:30:44	latitude	53.2734
<input type="checkbox"/>	2018-08-29 19:30:44	longitude	-7.77832031
<input type="checkbox"/>	2018-08-29 19:30:44	mac address	94:66:e7:29:29:29
<input type="checkbox"/>	2018-08-29 19:30:44	modelname	WA329P
<input type="checkbox"/>	2018-08-29 19:30:44	rssi	-1
<input type="checkbox"/>	2018-08-29 19:30:44	version	beta-08291739

8. If all of the data has been uploaded, user can create a dashboard to visualize the data. Go to Dashboards menu. In this page, user can upload the JSON file that sent by the WoMaster Sales in the email. Click the “+” to import JSON File or Create a new Dashboard.

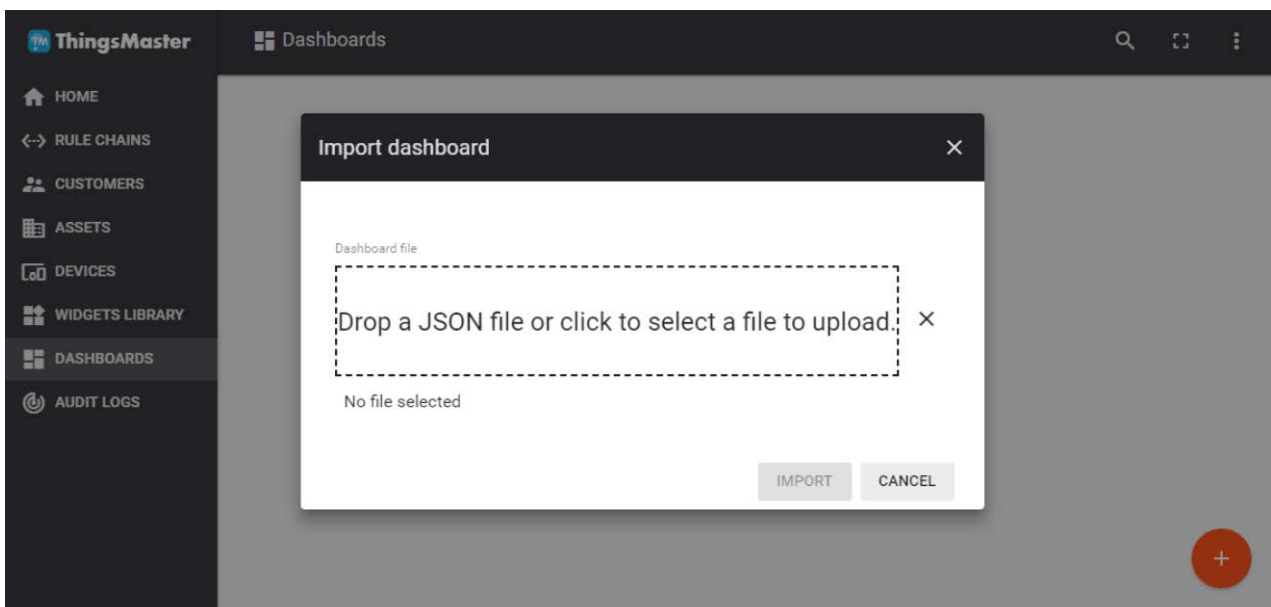

9. After the JSON file is uploaded, the dashboard will show as below:

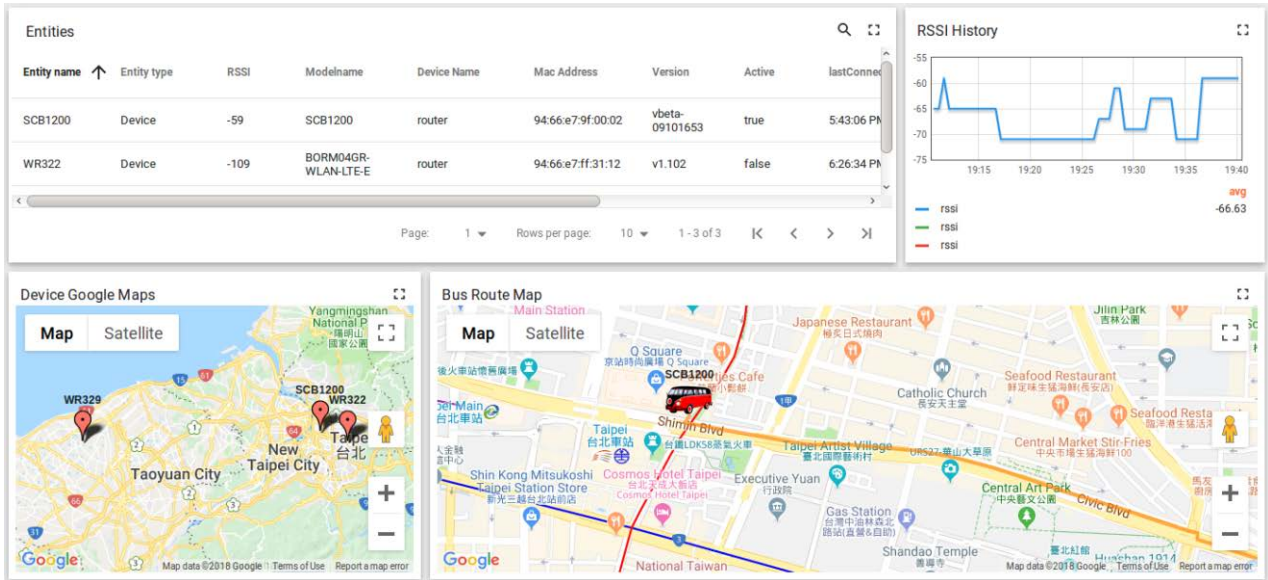

3.13 BACKUP AND RESTORE

User can use WoMaster Backup and Restore configuration to save and load configuration through the router. There are 2 modes for users to backup/restore the configuration file.

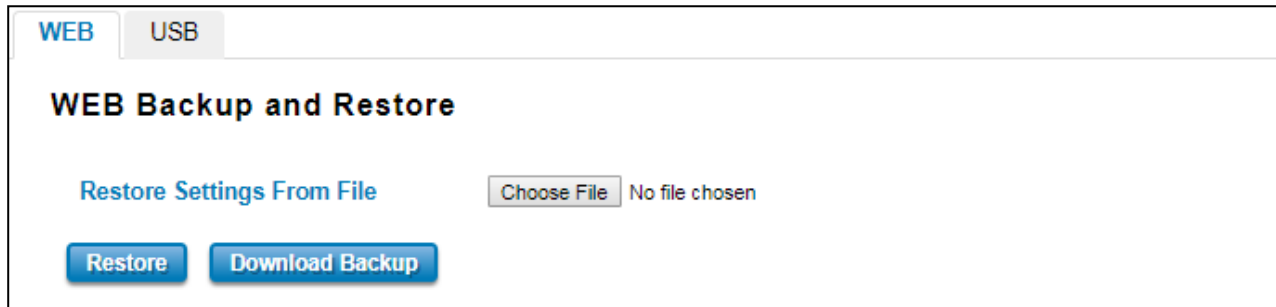

The screenshot shows the 'WEB Backup and Restore' interface. At the top, there are two tabs: 'WEB' (selected) and 'USB'. Below the tabs, the title 'WEB Backup and Restore' is displayed. Underneath, there is a section titled 'Restore Settings From File' with a 'Choose File' button and the text 'No file chosen'. At the bottom, there are two blue buttons: 'Restore' and 'Download Backup'.

Web mode: In this mode, the router acts as the file server. Users can browse the target folder and then type the file name to back-up the configuration. Browse the target folder and select existed configuration file to restore the configuration back to the router. This mode is only provided by Web UI while CLI is not supported. Also, this feature provides the Download Backup button in order to download the backup configuration from the router.

USB mode: this mode has two functions, Load Setting from File and Save Setting to USB. Load Setting from File, make sure that the USB has been inserted and it has the *.conf* file which is the backup files. After inserting the USB, the USB port will directly read the USB and then user needs to type the specific filename. Then click **Restore**. At the Save Setting to USB part, all of the configuration settings would be saved to the USB, with *.conf* as the file type by clicking the **Backup** button.



The screenshot shows the 'USB Backup and Restore' interface. At the top, there are two tabs: 'WEB' and 'USB' (selected). Below the tabs, the title 'USB Backup and Restore' is displayed. Underneath, there are two sections. The first section is 'Load from USB' with a text input field containing 'Example:router.conf' and a blue 'Restore' button below it. The second section is 'Save to USB' with a text input field containing 'Example:router.conf' and a blue 'Backup' button below it.

3.14 FIRMWARE UPGRADE

WoMaster provides the latest firmware online at www.womaster.eu. The new firmware may include new features, bug fixes or other software changes. WoMaster also provides the release notes for the update as well. For technical viewpoint, WoMaster suggests user uses the latest firmware before installing the router to the customer site.

NOTE: Note that the system will be automatically rebooted after User finished upgrading the new firmware. Please remind the attached network users before User performs this function.

There are 2 modes for users to backup/restore the configuration file, Web mode, and USB mode.

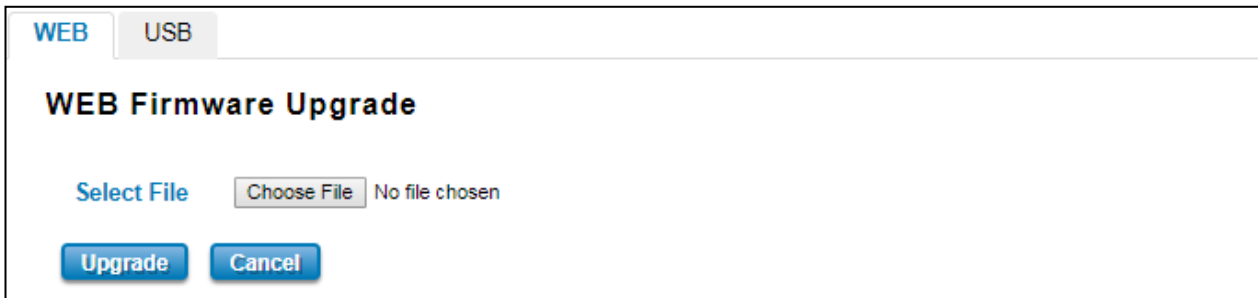

The screenshot shows the 'WEB Firmware Upgrade' interface. At the top, there are two tabs: 'WEB' (selected) and 'USB'. Below the tabs, the title 'WEB Firmware Upgrade' is displayed. Underneath, there is a 'Select File' button, a 'Choose File' button, and the text 'No file chosen'. At the bottom, there are two buttons: 'Upgrade' and 'Cancel'.

Web mode: The router acts as the file server. Users can browse the target folder and then type the file name to back-up the configuration. Users also can browse the target folder and select the existed upgrade file. This mode is only provided by Web UI while CLI is not supported.



The screenshot shows the 'USB Firmware Upgrade' interface. At the top, there are two tabs: 'WEB' and 'USB' (selected). Below the tabs, the title 'USB Firmware Upgrade' is displayed. Underneath, there is a 'File name' label and an empty text input field. At the bottom, there are two buttons: 'Upgrade' and 'Cancel'.

USB mode: plugged the USB device with the firmware file, then type the specific filename of the new firmware file. Then click **Upgrade**.

3.15 RESET TO DEFAULTS

This function provides users with a quick way of restoring the WoMaster router's configuration to factory defaults. By check the Restore Factory default IP setting, it means the IP of the device will directly change to the default IP (192.168.10.1).

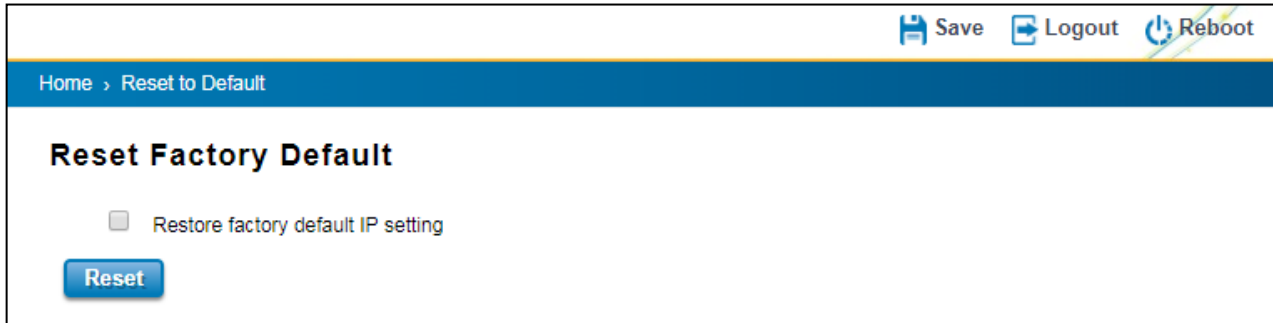

Pop-up message screen to show User that have done the command. Click on **OK** to close the screen and reboot the device.

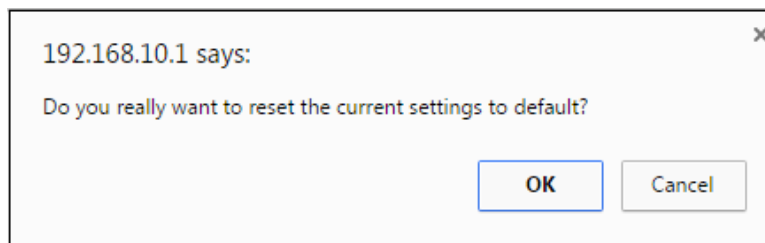

Below is the interface for resetting the device with keep the IP Settings.

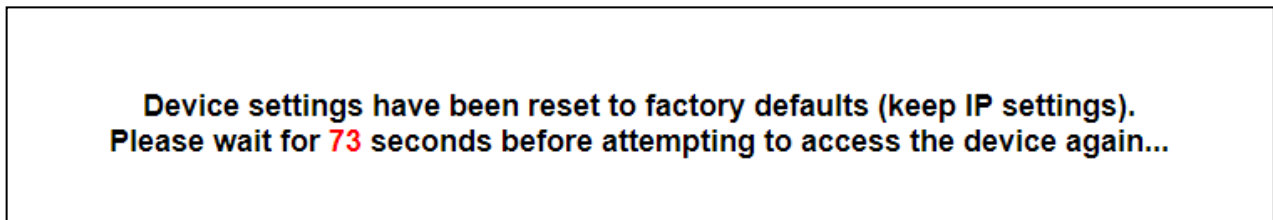

3.16 SAVE

Save option allows user to save any configuration. Powering off the router without clicking on **Save** will cause loss of new settings. After selecting **Save**, click on **Yes** to save new configuration.

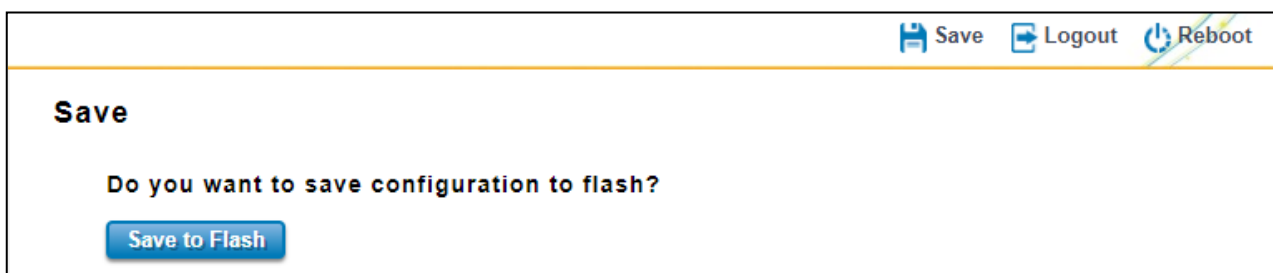

3.17 LOGOUT

There are 2 logout methods. If user doesn't input any command within 30 seconds, the web connection will be logged out. The Logout command allows user to manually logout the web connection. Click on **Yes** to logout.

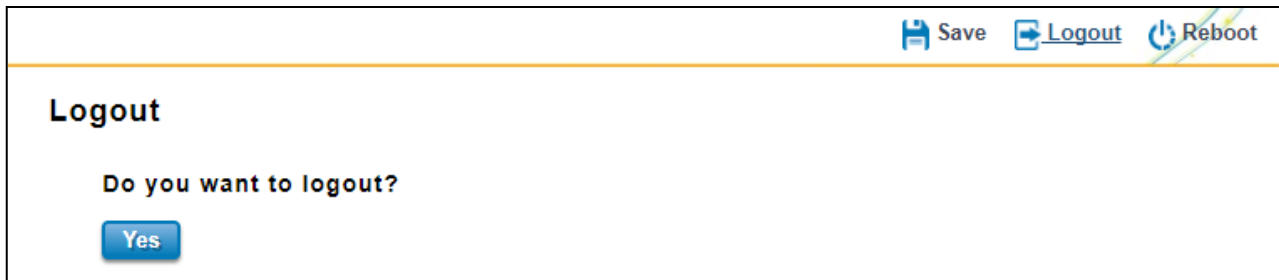

3.18 REBOOT

System Reboot allows user to reboot the device. Some of the feature changes require user to reboot the system. Click on **Reboot** to reboot device.

NOTE: Remember to click on Save button to save configuration settings. Otherwise, the settings user made will be gone when the router is powered off.

Reboot main screen, to do confirmation request. Click **Yes**, then the router will reboot immediately.



3.19 WOMASTER MIB

WoMaster provides Private MIBs for users to configure or monitor the device's configuration by SNMP. WoMaster provides Private MIB to meet up the need. Compile the private MIB file by SNMP tool or using WoMaster NMS, NetMaster. The Private MIB can be found in or downloaded from WoMaster Web site (www.womaster.eu). Private MIB tree is the same as the web tree. This is easier to understand and use. If user does not familiar with standard MIB, User can directly use private MIB to manage /monitor the device.

The table below is the MIB file and the supported model:

WOMASTER-SWITCH-MIB	DP310/DS310
WOMASTER-POE-MIB	DP612/DS612
	S409
	DP412/DS412
	MP310
	MP614
WOMASTER-ROUTER-MIB	SCB1000/SCB1200
WOMASTER-SERIAL-MIB	WR312/WR322
WOMASTER-CELLULAR-MIB	WR316
	DS306
	WR329
WOMASTER-GPS-MIB	SCB1000/SCB1200
	WR312/WR322 (GPS by request)
	WR316
	WR329

4. REVISION HISTORY

Version	Description	Date	Editor
V1.0	1 st released WR329 User Manual	2018/10/22	Yohan